

## Solubility of alkali metals in non-aqueous supramolecular systems

Zbigniew Jedliński and Maria Sokół

Institute of Polymer Chemistry, Polish Academy of Sciences, 41-800 Zabrze, Poland

**Abstract:** Blue potassium and potassium/sodium solutions in tetrahydrofuran or tetraglyme containing various complexing agents have been studied by means of  $^{39}\text{K}$  and  $^{23}\text{Na}$  NMR. The ionic composition of the systems is presented and the relaxation behaviour of the potassium solutions discussed and interpreted. The great influence of complexing agent on the magnitude of the ionic interactions is pointed out. A novel mechanism of metal dissolution in polar aprotic solvents is proposed. The utility of  $\text{M}^+$ /crown ether/ $\text{M}^-$  complexes as chemical reagents and homogeneous catalysts is demonstrated.

### Introduction

Over 130 years ago Weyl demonstrated the solubility of alkali metals in liquid ammonia<sup>1</sup>. Almost 100 years later Ottolenghi<sup>2</sup> and Dye<sup>3</sup> demonstrated the solubility alkali metals in organic solvents like amines and ethers. Due to crown ethers, cryptands and other synthetic and natural ligands<sup>4,5,6</sup> (Fig.1) capable of complexing alkali metal cations, concentrated metal solutions can be obtained<sup>7</sup>.

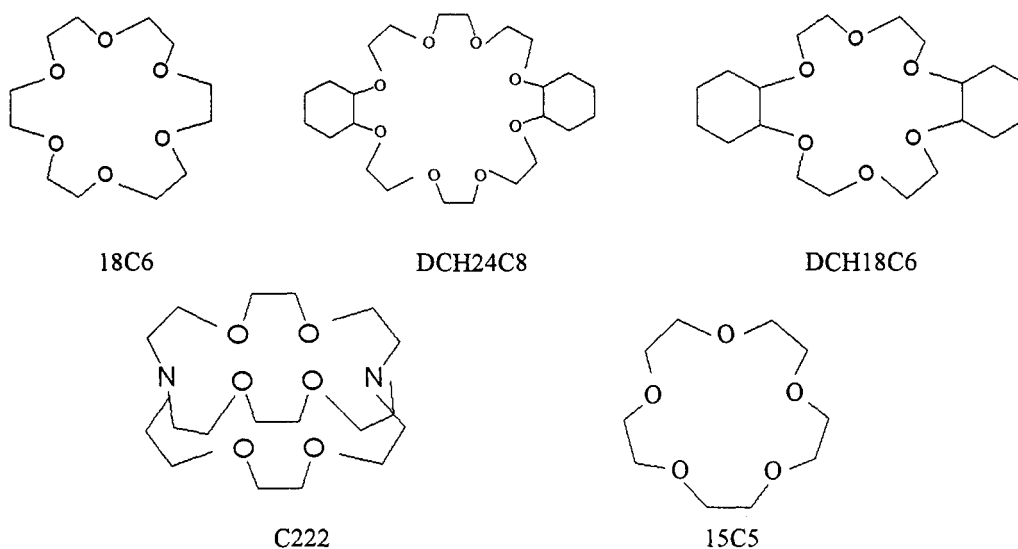

Figure 1. Macrocyclic ligands

Nowadays so called organic alkali metal solutions are still a subject of extensive research because of their interesting properties.

Lacoste and Schue<sup>8</sup> observed that solvated electrons are formed initially when potassium is dissolved in THF containing a crown ether. Our work rationalised their findings<sup>9</sup>. It has been confirmed that electrons along with complexed metal cations are the initial products of potassium solubilisation in THF containing 18C6.

The experimental results suggest that the process of metal dissolution is facilitated by the crown ether adsorption on the metal surface and process of metal dissolution can be roughly described by the following

equations (Scheme 1):



Indeed the removal of  $\text{K}^+$  from the metal lattice is expected to be a relatively slow process involving a potential energy barrier which could be reduced by adsorption of the crown ether and formation of a soluble  $\text{K}^+$  (crown ether) complex. Then, due to reaction by solvated electrons, diamagnetic  $\text{K}^-$  anions are formed (Eq.2). The process is strongly dependent on temperature, contact time of a ligand with metal surface, nature of a ligand, etc.. Playing with these factors one can control the process of metal dissolution and eventually the composition of the final solution.

Nowadays it is well known that alkali metals in the presence of simple crown ethers, e.g. 18-crown-6 (18C6), 15-crown-5 (15C5), cryptands (e.g. C222) and other ligands (Fig.1), can be dissolved in aprotic solvents like dimethyl ether<sup>10</sup> or tetrahydrofuran (THF)<sup>11,12,13,14</sup> yielding blue metal solutions containing ions and solvated electrons (Fig.2). Eventually due to some modifications such solutions contain predominantly loose metal ion pairs  $\text{K}^+(\text{crown})$ ,  $\text{K}^-$  and small amount of solvated electrons<sup>15</sup>.

However, the stability of metal solutions obtained is limited because the alkyl-oxygen bonds and especially aryl-oxygen bonds of cyclic ethers of a given ligand are sensitive towards alkali metals and are cleaved. From this point of view the temperature of the dissolution process as well as the contact time of the metal with solution are very important. Nevertheless the preparation of such solutions for practical applications is possible.

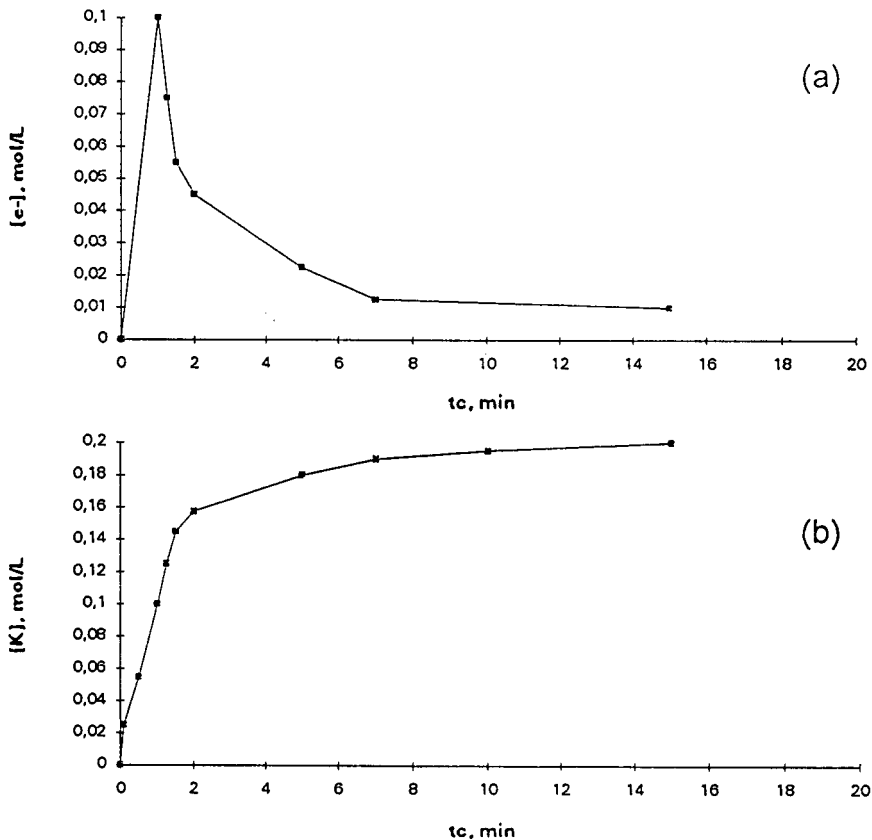

Figure 2 (a) Dependence of electron concentration on the time of contact,  $t_c$ , of the 0.1 M solution of the crown in THF with K mirror;  
(b) Dependence of K concentration in the solution on time of contact  $t_c$ .

### Preparation of Solutions Containing Metal Anions

We are using two techniques of preparation of organic alkali metal solutions (mainly in THF) in our lab.

The first technique includes preparation of metal mirror and next dissolution of the mirror. The apparatus for this purpose, made from borosodium glass, is shown in the Figure 3.

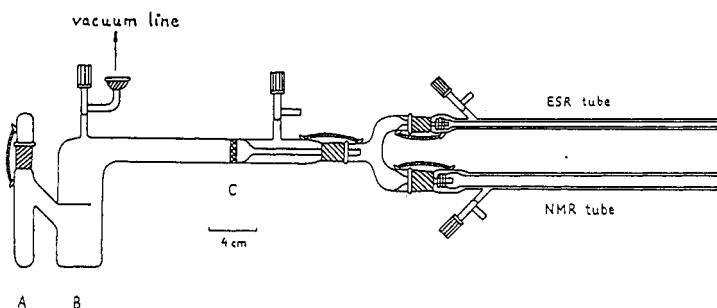

Figure 3. Scheme of the apparatus for preparation of metal solutions.

Small pieces of the metal (K, Na; ca 2-3g) are put into part A, melted and degassed at elevated temperature under the continuous flow of the inert gas (argon). The distillation is carried out in high vacuum ( $10^{-4}$  -  $10^{-5}$  torr). The walls of the receiving container (B) are covered with the metal mirror. The metal spread at the bottom is melted and degassed again. In the next step about 15ml of 0.1 - 0.2 M solution of complexing agent are introduced into the receiver under ultrasonic mixing. The resulting metal blue solution is filtered off through the glass frit to the NMR and ESR tubes for analysis and desired applications.

Another technique is based on a K-Na alloy dissolution. A similar apparatus is used, however without part A (Fig.3). The required amount of liquid alloy is introduced into the part B *via* a glass capillary under the flow of the inert gas. Then the apparatus is attached to the vacuum and after drying of the alloy the vacuum is cut-off. Then the solution of the complexant is introduced to the part B of apparatus, and then the procedure is the same as described previously.

Figure 4 presents the dissolution rates of the potassium mirror in THF containing various complexing agents at 293K. The dissolution rates for the solutions with dicyclohexano-18-crown-6 (DCH18C6)<sup>15</sup> or 18C69 are similar (Fig.4 curves 1 and 2, respectively). For a contact time of 15 min., the molar concentration of the metal anions is equal to that of the crown ether. The result is not surprising since both ligands are known to form 'flat' 1:1 complexes with a potassium cation located inside the oxacyclic ring<sup>16</sup>. In the system containing dicyclohexano-24-crown-8 (DCH24C8)<sup>15</sup> the total concentration of potassium metal reaches its maximum value (0.2 M) after the longer time ( $t_c = 25$  min). In the case of 15C5 the complex of a 'sandwich' form is probably formed.

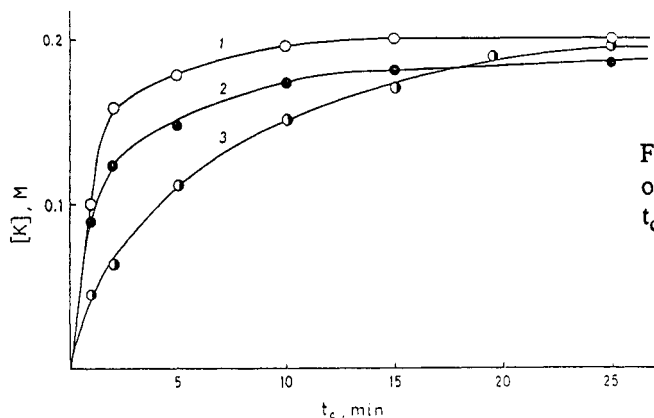

Figure 4. Solubility of potassium in THF vs time of contact of the solution with potassium mirror,  $t_c$ , in the presence of

- (1)  $[\text{DCH18C6}]_0 = 0.1 \text{ M}$ , data from<sup>15</sup>,
- (2)  $[\text{18C6}]_0 = 0.1 \text{ M}$ , data from<sup>12</sup> and
- (3)  $[\text{DCH24C8}]_0 = 0.1 \text{ M}$ , data from<sup>15</sup>.

### Stability of Metal Solutions

The stability of the solution is strongly affected by temperature. At higher temperatures (above 10-15°C) the concentration of  $K^+$  was found to decrease and the decomposition of the ligand occurs<sup>12,17</sup>. Lowering of temperature considerably increases the solutions stability.

Another factor determining the stability of the metal solution is the type of a crown ether used. It was possible to obtain the potassium solutions of enhanced stability when 15C5 was applied as a complexing agent<sup>12,13</sup>. The composition of the system was found not to change during about 100 min. at room temperature and the blue colour of the solution was retained for several hours even at higher temperatures. However, the decomposition of the potassium solution in THF containing 18C6 or DCH18C6 takes place at room temperature after about 1.5 h<sup>9,18</sup>.

On the other hand the solutions containing cryptands can be obtained only at temperatures below 253K, since at higher temperatures they decompose rapidly<sup>14</sup>. It means that the type of heteroatoms and the nature of a ligand affects the solution stability<sup>19</sup>.

The stability of metal solution may also vary depending on a solvent. Among various ethers used by us, e.g. glymes, tetrahydropyran, t-butyl methyl ether and tetrahydrofuran, the latter appears to produce the most stable system particularly at room temperature.

It is worth to note that some solvents may also act as a complexing agents. Such effect was observed for the potassium and potassium-sodium solutions in tetraglyme without the addition of crown ether<sup>20</sup>.

### NMR of Metal Solutions

Figure 5 display the representative <sup>39</sup>K NMR spectra of potassium solutions in THF containing 18C6, C222 and 15C5 at 223 K<sup>21</sup>. All spectra exhibit two resonance signals of nearly equal integral intensities. A narrow line can be assigned to potassium anions and a broader one is due to complexed potassium cations<sup>10,11,22</sup>.

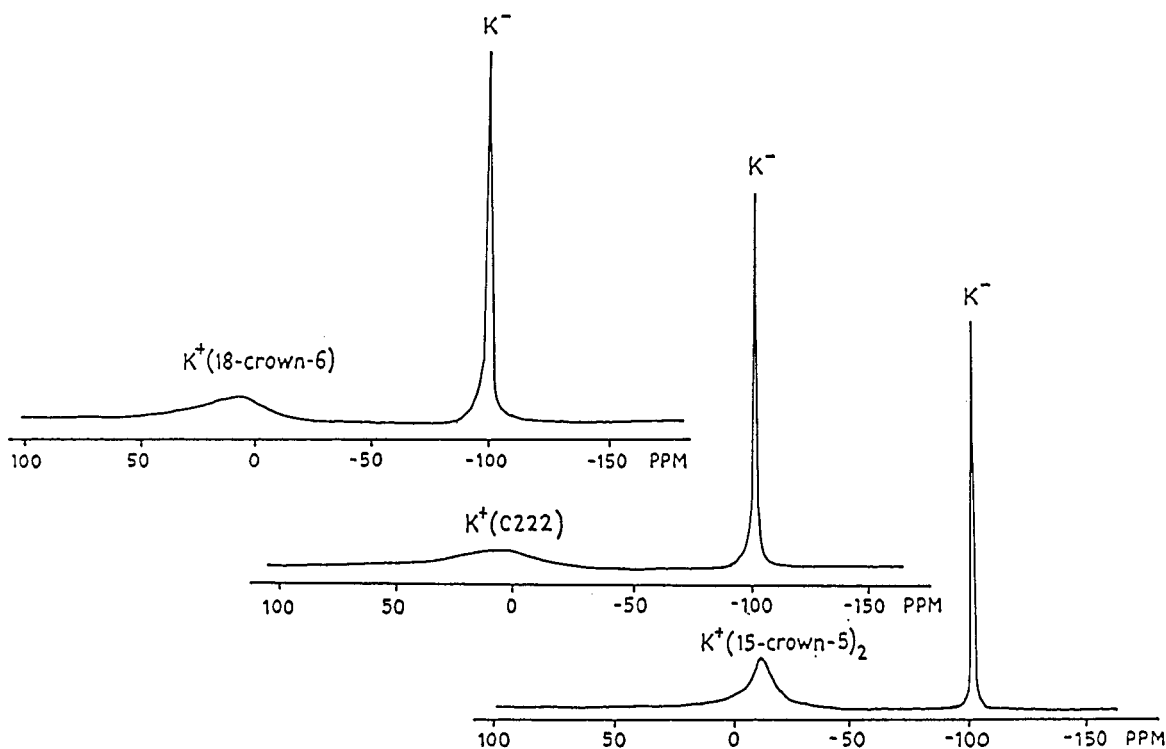

Figure 5. <sup>39</sup>K NMR spectra of potassium solutions in THF containing 18C6, C222 and 15C5 at 223 K.

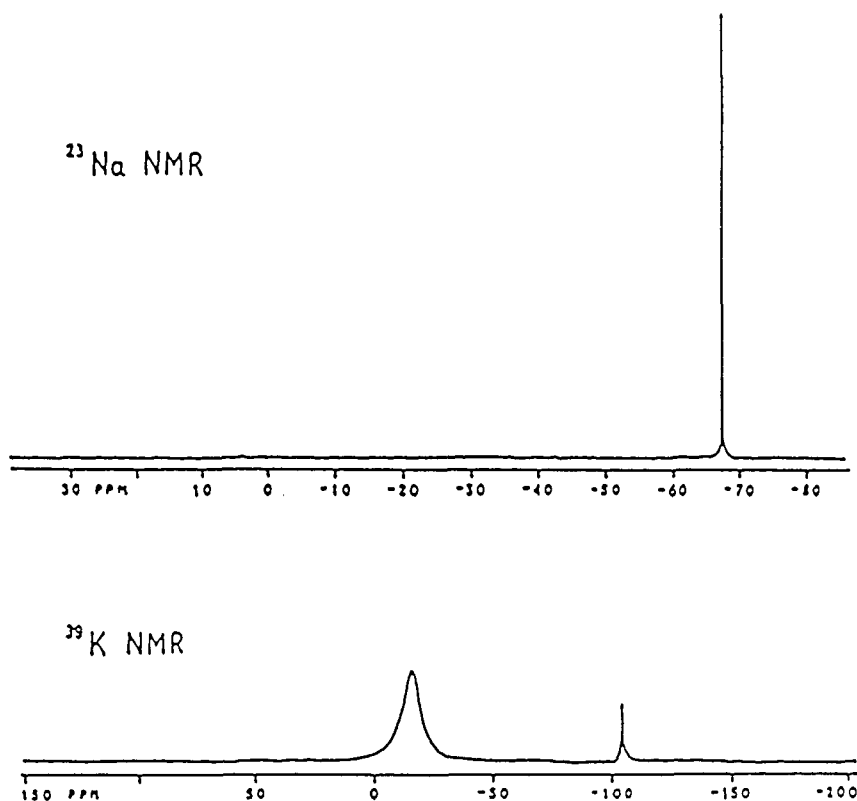

Figure 6.  $^{23}\text{Na}$  and  $^{39}\text{K}$  NMR spectra of potassium/sodium solution in THF containing 15C5 at 243 K.

The widths of the lines are influenced by quadrupolar and exchange broadening effects<sup>11,13,14,16</sup>. In all potassium solutions the  $\text{K}^+$  line widths are markedly greater than those of the  $\text{K}^-$  line. The difference in the cation and anion line widths may be explained by lower spherical symmetry of the electric field sensed by the cation and/or an increased rotational correlation time characterising the fluctuations of the cation environment<sup>11,16</sup>. Both lines may also be broadened to some extent by the presence of paramagnetic species due to paramagnetic interaction and/or a modification of potassium nuclear quadrupole coupling constant by  $e_s^-$  present in the system<sup>11,13</sup>.

The line width due to  $\text{K}^-$  depends on the ligand applied for the counter ion complexation and decreases at 223 K in the following order: 18C6  $\approx$  DCH24C8 > DCH18C6 > C222 > 15C5. It is due to an increasing ability of a complexing agent to separate  $\text{K}^+$  and  $\text{K}^-$  from mutual interactions<sup>13</sup>. In the case of 15C5 the relatively narrow line is observed also for  $\text{K}^+$  in contrast to the other studied system<sup>13</sup>. In this system the potassium cation resides between two 15C5 molecules in a 'sandwich' fashion<sup>16</sup>. Such an arrangement reduces the availability of interionic interactions<sup>13,16</sup> (Fig. 5,6).

The  $^{39}\text{K}$  NMR method was also employed for studying a stability of metal solutions at room temperature. The sequential recording of the spectra, starting at room temperature for the freshly prepared solution, enables the investigation of the changes in the composition of the system vs time. For the potassium solutions in THF containing 18C6 or DCH18C6 the integral intensities of the  $\text{K}^+$  and  $\text{K}^-$  resonances decrease with the same rate indicating that some decomposition processes take place. However in the case of 15C5 the rate of decomposition is rather slow<sup>12</sup>.

### Potential applications of potassium solutions

Dye utilised alkali metal organic solutions for the preparation of alkali metal organics and electrides<sup>23</sup>. Potassium solutions, although not precisely characterised, were also applied previously for reduction of some aliphatic and aromatic hydrocarbons and acid derivatives, like esters, nitrites, etc.<sup>24,25,26</sup>.

Our study on metal dissolution and composition of obtained solutions revealed that under proper conditions solutions with a high concentration of anions and negligible amount of electrons can be produced. Well defined solutions containing potassium or sodium anions as anionically active species have been employed as reagents or catalysts for organic synthesis. The great utility of this reagent, especially for the enolization of ketones<sup>27</sup>, ring opening reactions of lactones and cyclic ethers<sup>28</sup>, metalation reaction<sup>29</sup> has been demonstrated, the mechanism of these reactions being also studied.

It turned out that depending on the nature of a substrate potassium anion can react in a different manner. Transfer of one or two electrons towards a suitable acceptor is possible, as well as proton abstraction, as shown schematically:

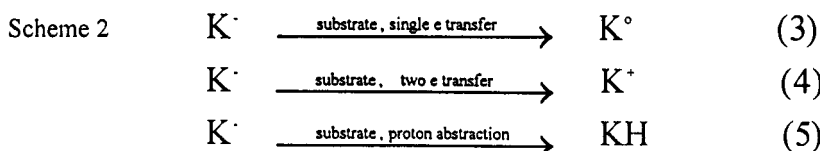

The unexpected new reaction involving two electron transfer from potassium anion to the  $\beta$ -lactone molecule resulting in C-C bond scission of the  $\beta$ -lactone ring was also demonstrated<sup>28</sup>. It is the first example of carbon-carbon bond cleavage that occurs in heterocyclic compounds.

## References

1. Weyl, A., *Ann. Phys.* **1864**, *197*, 601.
2. Ottolenghi, M., Bar-Eli, K., Linschitz, H., Tuttle, Jr. T. R. *J. Chem. Phys.* **1964**, *40*, 3729.
3. Dye, J. L., De Backer, M. G., Nicely, V. A., *J. Am. Chem. Soc.* **1970**, *92*, 5226.
4. Pedersen, C. J., *J. Am. Chem. Soc.* **1967**, *89*, 2495.
5. Lehn, J. M., *Struct. Bond.* **1973**, *16*, 11.
6. Cram, D. J., Cram, J. M., *Science* **1974**, *32*, 803.
7. Dye, J. L., *Prog. Inorg. Chem.* **1984**, *32*, 327.
8. Lacoste, J., Schué, F. J., *Organomet. Chem.* **1982**, *231*, 279.
9. Jedliński, Z., Stolarzewicz, A., Grobelny, Z., Szwarc, M., *J. Phys. Chem.* **1984**, *88*, 6094.
10. Tinkham, M. L., Dye, J. L., *J. Am. Chem. Soc.*, **1985**, *107*, 6129.
11. Sokół, M., Grobelny, J., Jedliński, Z., *Magn. Res. Chem.*, **1990**, *28*, 934.
12. Grobelny, Z., Stolarzewicz, A., Sokół, M., Grobelny, J., Janeczek, H., *J. Phys. Chem.*, **1992**, *96*, 5193.
13. Sokół, M., Grobelny, J., Grobelny, Z., Stolarzewicz, A., *J. Phys. Chem.*, **1993**, *97*, 763.
14. Sokół, M., Grobelny, J., Grobelny, Z., Jedliński, Z., *Spectrochim. Acta*, **1991**, *47A(11)*, 1547.
15. Grobelny Z., Sokół M., unpublished data
16. Dye, J. L. In: *Progress in Macrocyclic Chemistry*; Izatt, R. M., Christensen, J. J., Eds.; Wiley-Interscience: New York, **1979**; *Vol. 1*, p.63.
17. Jedliński, Z., Stolarzewicz, A., Grobelny, Z., *Makromol. Chem.*, **1986**, *187*, 795.
18. Grobelny, Z., unpublished data
19. Dye, J. L., *Pure Appl. Chem.*, **1989**, *61*, 1555
20. Grobelny, J.; Sokół, M.; Jedliński, Z., *Magn. Res. Chem.*, **1991**, *29*, 233.
21. Jedliński, Z., Sokół, M., Grobelny, J., *J. Phys.*, **1991**, *1*, 291.
22. Edwards, P. P., Ellaboudy, A. S., Holton, D. M., *Nature (London)*, **1985**, *317*, 242.
23. Dye, J. L., *J. Phys. Chem.*, **1984**, *88*, 3842.
24. Barrett, A. G. M., Prokopiou, P. A., Barton, D. H. R., Boar, R. B., Mcghe, J. F., *J. Chem. Soc., Chem. Commun.*, **1979**, 1173.
25. Barrett, A. G. M., Prokopiou, P. A., Barton, D. H. R., *J. Chem. Soc., Perkin Trans. 1* **1981**, 1510.
26. D ewald, R. R., Jones, S. R., Schwartz, B. S., *J. Chem. Soc., Chem. Commun.*, **1980**, 272.
27. Jedliński, Z., Misiołek, A., Główkowski W., *Synlett*, **1990**, 213.
28. Jedliński, Z., Misiołek, A., Kurcok, P. *J. Org. Chem.*, **1989**, *54*, 1500.
29. Jedliński, Z., Misiołek, A., Jankowski, A., Janeczek, H., *J. Chem. Soc., Chem. Commun.*, **1991**, 1513.