

METAL IONS IN BIOLOGICAL CATALYSTS

Robert J.P. Williams

Inorganic Chemistry Laboratory, Oxford University, Oxford, England

Abstract - The role of inorganic elements in enzymes is discussed. The first point of note is that strong retention of metal ions by a protein is limited to certain metal ions, mainly copper, zinc and molybdenum. A further group of metals can be retained but largely in coenzymes, iron, cobalt, nickel and magnesium. Many aquated metal ions are in intermediate or fast exchange, iron, manganese, magnesium, and calcium. The last group of ions act as controls as well as catalysts. In the light of the limitations and value of proteins as ligands for metal ion catalytic centres, the functional value of different metals is described under π -acids, σ -acids, oxidation state ranges and potentials. It is concluded that biological systems have evolved so as to bring out the optimal value of metals in catalysis. This explains the use of different metals in very different catalytic steps and the nature of the peculiarities of the sites selected for each metal.

INTRODUCTION

Inorganic elements in biological systems are used for very diverse purposes: the carrying of ionic messages, Na, K, Ca, Cl; the triggering of proteins, Ca, P; in structures, Ca, P, Si; in electron transport, Fe, Cu, Mn; and in catalysis, many elements (Ref.1). In a previous paper I have outlined the ways in which each element has had its functional potential raised during evolution through association with particular proteins. In compounds between the elements and proteins two extreme forms of binding have been found, surface and interior binding, as shown in Fig.1. Surface binding can be used in the transport of elements, in message transmission, in structure, and in triggering but is limited in its value in catalysis. A difficulty arises since many of the catalytic elements are held by largely ionic bonds, e.g. most catalytic *metal* ions, and they would therefore readily exchange from protein surfaces. Given the low availability of most metal ions, catalysts formed from metals and proteins would then dissociate. The catalytic metals are therefore held in the protein interior. A potential limitation on catalysis by metal ions in proteins and which does not apply to the covalently constrained non-metals, e.g. Se, is therefore that the metal must be partially hidden in a protein by quite strong thermodynamic interaction i.e. by at least three ligands, Fig.1. The stipulation of three ligands rises from considerations of stability constants, see below. Such internal sites immediately affect the steric accessibility of the metal, i.e. substrate specificity, and introduce strain both in the metal-protein bonds and in the protein fold, as well as in the dynamics of these bonds and folds. At first sight this might be thought to be disadvantageous but it allowed evolution to generate particular site geometries and dynamics to match catalytic purposes. Vallee and Williams (Ref.2) referred to the compromised geometries at the metal as the entatic state of the catalytic site. Similar strains are common to some non-metal enzymes but are harder to detect since metal ions provide a wealth of spectroscopic information about sites absent from simple non-metal sites.

Now this discussion and Fig.1 divides very rapid metal ion exchange from effectively no exchange situations but it is clearly possible to devise intermediate binding giving rise to intermediate rates of exchange. In fact the exchange rates of ions from relatively strong binding sites, a product of the strength of binding and the activation free energy for release, fall in the order

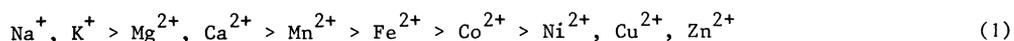

This order is quite different from the order of exchange of weakly held ligands of metal ions e.g. water from metal ions. For water exchange the order is

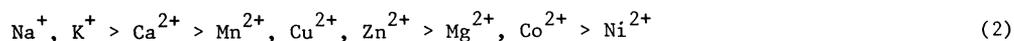

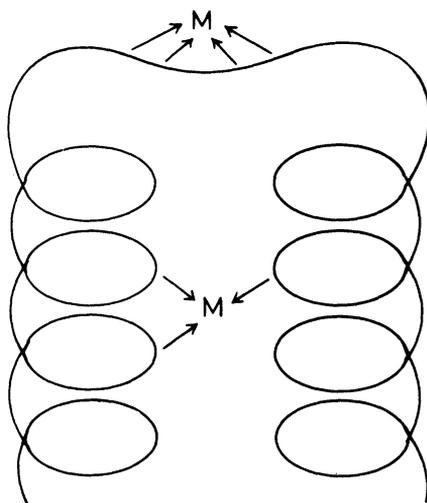

Fig. 1. The two extremes of metal ion binding (a) in the centre of a protein where the metal ion is catalytic and (b) on the edge of a protein where it acts as a trigger.

TABLE 1. Some Entatic States of Enzymes

Enzyme	Peculiarities of Site
Azurin, Plastocyanin	Tetrahedral, <i>Cu-methionine</i> bond is anomalous. One thiolate and two imidazoles.
Superoxide Dismutase	Distorted tetragonal, four imidazoles. Cu(I) ligands, <i>Fifth coordination site</i> unusual.
Laccase	(a) See azurin, copper (<i>tetrahedral</i>) (b) Type II copper - <i>fluoride binding high</i> (c) Strong copper dimer of <i>high</i> redox potential, see Fig. 7.
Carbonic Anhydrase	Four/five coordinate zinc with three imidazoles and <i>acidic</i> water, see Fig. 3.
Alcohol Dehydrogenase	Four coordinate zinc with two thiolates and one water (?) <i>replaceable</i> by alcoholate.
Carboxypeptidase	Four/five coordinate with two imidazoles, one carboxylate and one/two waters.

Note. The metal-ligand and the geometry are idiosyncratic for each metal in each protein of a class.

The first order is important for the stability of catalysts while the second must be important in the on/off rates of enzyme substrates. We describe the stability of the catalysts first. The sequence of rates in (1) implies that intermediate rates of metal ion exchange will be found for manganese, iron and cobalt. In turn it follows that all these three divalent metal ions, as well as magnesium and calcium, could be used by restricting their free ion concentrations, in the control of the concentration of a catalyst as well as directly in catalysis. For very different reasons this combination of control and catalysis is not a possible operational use of Na^+ or K^+ , (too weakly bound and very weak catalysts) nor of Ni^{2+} , Cu^{2+} , Zn^{2+} , too strongly held. Elsewhere we have described how calcium and magnesium concentrations are used to control catalysts although they are not very catalytic in themselves and the evidence for their use in control is conclusive. The possible use of Mn and Fe in a related way has been published (Ref.3). Manganese and iron may be slow regulators of biological activity affecting overall steady-states while calcium and magnesium are fast triggers. Mn(II) and Fe(II) then act both as catalytic groups and as controls.

Coordination chemistry of metal/protein complexes

The limitations imposed by at least three bonds from the protein to the metal, Fig.1, are increased by the limited range of coordination-centres which a protein can provide and which give adequate stability. The potential liganding centres for metal ions are carboxylates, imidazoles, thiolates, amines and phenolates. Of these amines have a pK_a of around 11.0 and at $\text{pH} = 7$ are ineffective ligands for either divalent or trivalent ions. No metal to amine bond has been observed in any catalytic protein so far. Phenolate and thiolate are also of high pK_a but since they are anions of high donor strength they can and do form protein to metal links especially to trivalent ions. Phenolate binding is restricted so far as is known to trivalent ion binding. We stress that the common trivalent ions need anionic sites to retain them without exchange or hydrolysis at $\text{pH} = 7$ while this is not the case for some di- or monovalent cations.

The nature of the coordination spheres are listed in Table I. The table includes some sites which are not useful for catalysis including structural sites for zinc (four tetrahedral thiolates) and electron transfer sites for copper (four sites of distorted tetrahedral geometry) and for iron (four tetrahedral sites or six octahedral sites) where substrate access is totally blocked. There are as well some surface carrier sites for Fe(III) and Mn(III) (not Fe(II) or Mn(II)) which may well be blocked e.g. by CO_3^{2-} . In this article only metal sites with residual open coordination sites in the coordination sphere are of interest.

We see that protein side-chains have gross limitations as ligands, especially for the binding of Fe, Co and Mn. Biological systems have produced an answer to this problem which is to make special ring chelates for iron, cobalt, (nickel) and magnesium so that these ions can be irreversibly retained in haem, corrin and chlorin for example. The ring chelates also introduce low-spin chemistry of iron (nickel) and cobalt which has particular advantages in catalysis, see below. The nature of proteins and of small cofactor chelating agents and their rates of synthesis have generated during evolution special highly selected protein/metal ion associations. The thermodynamic and kinetic factors controlling the formation of these complexes has been analysed previously.

In addition to these centres there are multinuclear more or less *permanent* complexes of iron, copper, molybdenum (?), manganese (?) and iron with copper. These centres are reserved for the reactions of H_2 , N_2 and special reactions of O_2 in multi-electron processes. Of them the ones most open to metal ion dissociation are the Fe/S and the manganese centres.

Returning to mononuclear sites the following general statements apply to *catalytic* sites

- (1) Zinc(II) is held *permanently* by three ligands usually imidazole and thiolate but sometimes there is one carboxylate. The complex is usually positively charged and is an open-sided distorted tetrahedron holding one or two water molecules.
- (2) Copper(II) is held *permanently* by three or four ligands usually imidazole in open-sided distorted tetragonal symmetry with one or two water molecules or sulphur donors. The Cu(II) site is positively charged.
- (3) Only Cu(I) of monovalent cations can be retained by protein side-chains. It can be held by three N/S donors with one vacant site of a rough tetrahedron.
- (4) Nickel(II) is *predicted* to be held (*permanently*) by four ligands in a rough octahedron probably two (or three) imidazoles and one or two carboxylates. It is held in the high-spin state. Geometry restrictions will select Ni(II) from Zn(II) in a protein. Ni(II) will then be found with one or two bound water molecules.
- (5) Cobalt(II), Iron(II) and Manganese(II) cannot be retained permanently by protein side-chains at *mononuclear* sites. (see clusters below). Their sites are therefore simultaneously potential sources of control and catalysis but their instability introduces problems in catalytic sites. The sites have at least one imidazole and one or two carboxylates and are six coordinate leaving one or two sites occupied by water. Discrimination between nickel, iron and manganese is based on cavity size and the number of N-donors.
- (6) Iron(III) is held *permanently* by four ligands of increased anionic dominance, e.g. three carboxylate, phenolate, thiolate groups, and one or two imidazole donors and manganese(III)

will be held by similar ligands but in a different geometry. Again one site is available as in hemerythrin.

(7) Iron, cobalt and possibly nickel in a variety of oxidation states are retained *permanently* by a rigid ring chelates such as porphyrin and corrin, which now generate low-spin states and where they are bound to one protein ligand they have or can yield an open sixth coordination site.

(8) Molybdenum(III) to (VI) can be retained *permanently* by thiolates perhaps on the surface of a protein unlike all other metal ions. The binding of $\text{MoO}_2(\text{OH})_4$ may be similar to that of $\text{B}(\text{OH})_3$ or $\text{Si}(\text{OH})_4$ but is likely to be through condensation with -SH groups. Such condensation reactions are not entropy driven and have a different selectivity from cation/anion reactions. One of the Mo coordination sites is available for reaction or can become an open site on reduction.

Positioning of catalysts in space (Ref.3)

The permanent association of particular metals with particular proteins allowed the further development that a given metal could be selectively placed within one of the compartments of an organism or even of a cell. For example, it is a consequence of the stability of metal-protein complexes that copper not iron containing oxidases could be safely used outside cells and it is a consequence of iron pumping and local protein synthesis that iron enzymes are common in the cytoplasm of prokaryotes and mitochondria. The catalysts are also positioned in the compartments. The organisation of the cytochrome chain is only possible through the selective recognition of specific proteins which carry specific metals in special sites. These matters are discussed in Ref.1-3 but they explain why copper and iron proteins when *isolated* may appear to overlap in function when in fact they act in different compartments *in vivo*.

In the light of these restrictions we can ask about the nature of the residual coordination positions of the metals and which are not bound by protein and which must be used in catalysis, remembering that the limitations of protein coordination chemistry will profoundly affect the catalytic potential as will the protein composition, fold and energetics.

METAL-IONS AS π -BASES

The binding of unsaturated ligands such as O_2 requires that the metal acts as a π -electron donor, see (Ref.4). It is well-known that Fe(II), low-spin, and Cu(I) are outstandingly effective in this regard. All known oxygen-carriers and activators in biology use these two metals or occasionally flavin. Probably this difference between Fe(II) and Cu(I) on the one hand and Mn(II) which is high-spin and a very poor π -base on the other, together with their very different ranges of redox potentials, see below, has led to the evolution of the manganese O_2 -generating enzyme and the iron and copper O_2 -utilising enzymes. This distinction is universal. The role of porphyrin in making Fe(II) low-spin states available generated a very good π -acid where none was available from protein side-chain Fe chemistry. The preferred coordination is then open as in hemoglobin and not blocked by water. The cases of the O_2 -carriers hemerythrin and hemocyanin, will be discussed again below under acid-base and redox reactions of multinuclear sites.

METAL-IONS AS σ -ACIDS

Both divalent and trivalent metal ions are potentially good σ -acids. Biology is very short of σ -acids since pH = 7 excludes H^+ except in bound form. It is of course very rich in σ -bases such as carboxylate, imidazole, thiolate and so on. Acid/base catalysis in enzymes often depends on such bases. We must look at the use of metal ions as acids and then ask where and why this mode of acid attack has arisen.

Amongst divalent ions the best Lewis acids are given again by the Irving-Williams series



but as stated earlier only Ni, Cu and Zn can be retained by protein side-chains. Retention in a porphyrin (Fe) or corrin (Co) reduces the σ -acidity of the metal, while increasing its π -donor power, so that Fe(II) does not even bind water in say myoglobin. Biology has only Ni, Cu or Zn as good divalent σ -acids. Strikingly the best, Cu(II), is never used while Zn(II) is extremely common (>100 examples), Fig.2. Ni is used now and then. However Zn(II) and Ni(II) do not catalyse the same class of reactions. Zn(II) is used to attack the major biological polymers and in their synthesis, i.e. phosphate esters, peptide bonds and saccharases. Ni(II) is used to hydrolyse a few urea-like substrates. The question which forces itself upon our attention is why does biology use zinc so frequently? Zinc is of course somewhat more available than copper or nickel.

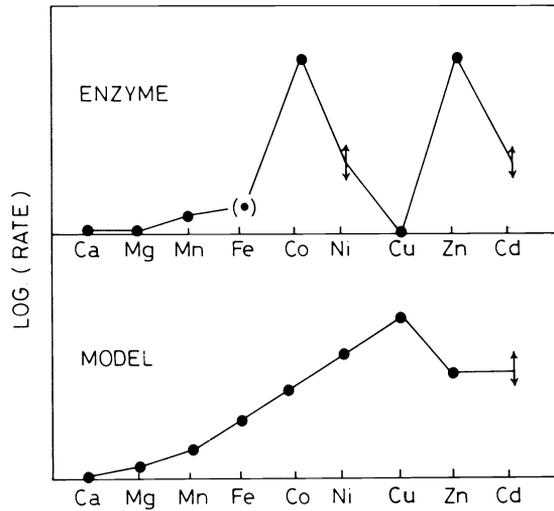

Fig. 2. The σ -acid properties of metal ions showing at the bottom the observed behaviour in model catalysis (schematic) and above the cases of carbonic anhydrase and phosphatases. Proteins have evolved so as to select the appropriate metal ion and to generate its optimal geometry and motion in a reaction.

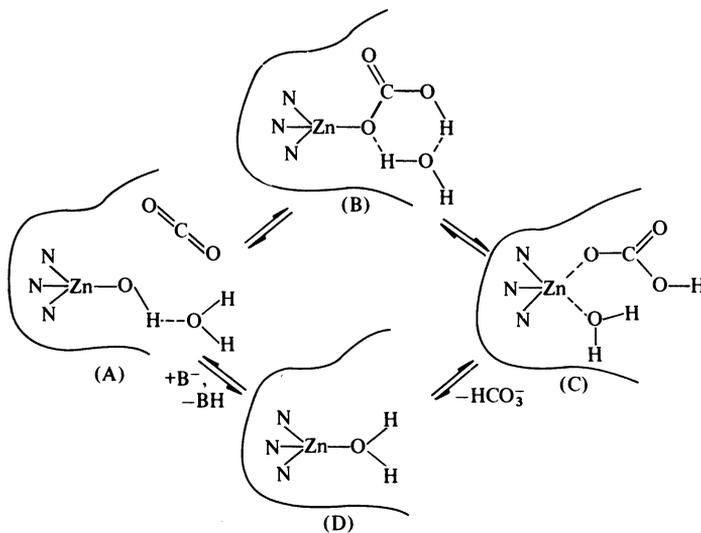

Fig. 3. The proposed reaction cycle of carbonic anhydrase, see refs.5 and 6. The metal ion acts as an acid both in four and five coordinate states and also serves to hold substrates in the correct alignment while adjusting its own geometry. The geometry is decided by the protein and the metal sits in the middle, see Fig. 1(a).

[The different uses of different metals which apparently could carry out the same reactions is an intriguing feature of biological systems. There is some overlap of function - for example metallo- and non-metallo proteases, aldolases etc. but this is rare. The idiosyncratic use of elements suggests a very high level of utilisation of their slightly different properties and we must try to understand this biological development which is apparent in both acid/base and redox reactions].

Note that zinc in proteins has the following additional advantages

- (i) When placed in a site of low coordination number, say when it is held by three protein ligands and one water in a rough tetrahedron, which it enters readily unlike Ni(II), its acid strength is increased. In this respect its acidity considerably exceeds that of Ni(II) which prefers octahedral geometry.
- (ii) It is not a redox reagent, contrast Cu(II), and therefore cannot damage biopolymers by radical side-reactions.
- (iii) OH^- and H_2O enter and leave the zinc coordination sphere very rapidly. They can then undergo rapid catalytic cycling. The slow exchange of ligands of trivalent ions and of nickel makes zinc preferable for rapid reactions.
- (iv) Zinc reaction rates are assisted by its flexible coordination chemistry.

Examination of the zinc sites in proteins such as carbonic anhydrase, leaves little doubt that the bio-inorganic chemistry of zinc has been tuned (entatic state) for its function. Fig.3 shows the probable mechanism of the $\text{CO}_2/\text{H}_2\text{O}$ reactions (Refs.5 and 6). The metal switches ionisation state and its low coordination geometry while being a highly effective acid. A consequence of all these factors is that zinc as well as being an acid *per se* is a source of OH^- as an attacking base in protein catalysts. May be this is why zinc is so commonly used in biology when very fast acid-base reactions are required e.g. carbonic anhydrase, phosphate ester, i.e. DNA and RNA, synthesis and hydrolysis. Is Zn(II) the best of all possible acid catalyst centres?

The other divalent metal ions which act seemingly as acids, Mg(II), Mn(II) and Ca(II) in enzymes may well be better described under dissociable control co-factors necessary for substrate binding but relatively unimportant in the polarisation of substrates. Examples are phosphate transfer and hydrolysis, Mg(II) and Ca(II); glycosyl transfer and hydrolysis, Mn(II) and Ca(II); lipid hydrolysis, Ca(II), (Ref.3). All these reactions are of low activation energy and do not have to proceed inordinately rapidly so that on neither count do they need powerful acid catalysts. The control exerted by these ions is usually effected by control over their relative concentrations in different biological compartments, Fig. 4 & 5.

Trivalent ions as acids

Now we have outlined the virtues of the divalent ions as acid catalysts we should turn to the possibility of using trivalent cations, i.e. Fe(III) and Mn(III) in particular. Cobalt is a rare element only known in biology in vitamin B_{12} where no acidic function of the metal is possible. Now the same objections to the employment of Fe(III) and Mn(III) as acids can be raised as were raised against Cu(II). Their redox properties introduce risks of indiscriminate free radical reactions which biology must avoid. The acid/base functions of the copper(II), iron(III) and manganese(III) in proteins are therefore mainly used to bind quite different substrates than those of the zinc(II) Table 2. Most of them are the substrates which are required to undergo redox reactions. This is an evolved selection within biology, a symbiosis of metal function and associated protein binding selectivity.

While the same objections as those levelled against Cu(II) prevail against the use of Mn(III) and Fe(III) as acid catalysts inside a cell, outside cells the objection is less serious. When the outside environment is a very acid compartment the use of Zn(II) is seriously restricted. $\text{Zn}^{2+}\text{-OH}^-$ and even zinc proteins are then not stable. The protein complexes of Fe(III) and Mn(III) have much higher stability constants and both Mn(III) and Fe(III) remain powerful acids possibly giving M(III)-OH^- even at as low a pH as 3.0. This may well explain the finding that many acid phosphatases, in lysozymes or outside cells, are Fe(III) or Mn(III) enzymes. They do not have the effectiveness of zinc at higher pH however since ligand exchange is much slower from trivalent ion complexes. [In passing note that it is very likely that eukaryotic cells pump iron and manganese into mitochondria and remove copper as copper proteins to the outside cells, leaving the cytoplasm (pH=7) as the domain of zinc chemistry].

Acid functions in redox enzymes

The striking feature of the acid/base reactions of metal ions in redox enzymes is that the ions bind almost invariably to very small substrates, e.g. $\text{O}_2^{\cdot-}$, HO_2^- , CNS^- , NO_2^- , SO_3^{2-} , H_2O , CO , CH_4 , N_2 , H_2 , O_2 , NO_3^- , SO_4^{2-} . Exceptions may be found in the cases of the Cu amine oxidases and the Fe phenolate oxidases in which Cu(II) and Fe(III) may well be used to polarise large substrates, amines and phenolates, so that the substrates can be attacked directly by oxygen. This suggests that nearly all the metal sites have but one coordination position vacant and have extremely restricted free space around them, see Fig.1. While the lower

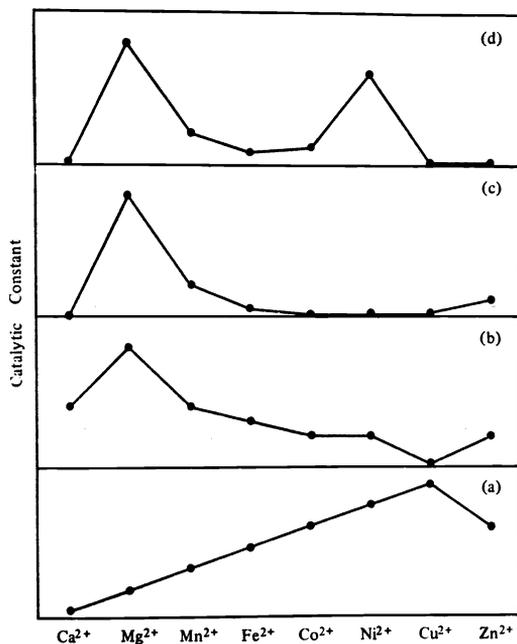

Fig. 4. The relative binding constants of metal ions for ligands (bottom) compared with the effect of metal ions on various phosphate transfer reactions. The middle two are two different kinases while the top graph is for phosphoglucomutase. In a kinase Mg. ATP is the substrate but Mg^{2+} really acts to stabilise free ATP. In phosphoglucomutase the cation helps to neutralize charge.

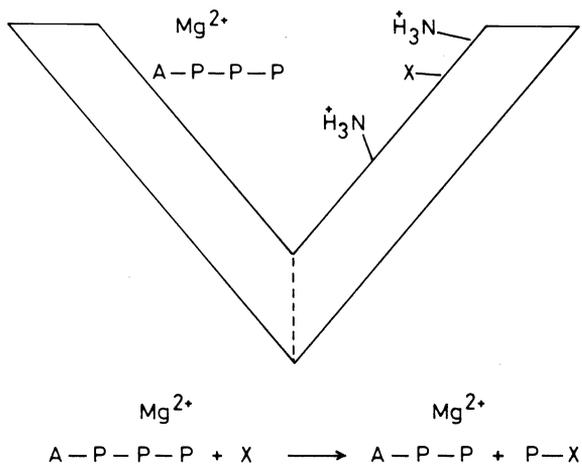

Fig. 5. The types of reaction centre found for Mg^{2+} in such enzymes as kinases. The interaction with the enzyme is minimal and only on the surface, see Fig. 1(b).

oxidation states, Cu(I), Fe(II), bind to the neutral molecules, e.g. O_2 , H_2 , CH_4 , N_2 , CO the higher oxidation states Fe(III) react with $O_2^{\cdot-}$ and HO_2^- and higher oxidation states still Mo(IV) are used to react with SO_4^{2-} , NO_3^- . We see again that well-known inorganic chemical principles of selectivity (Ref.7 and 8) have been turned to full advantage in that the associated proteins help to select the substrates which are most readily attacked by the chosen metal, already bound by this particular protein.

The acid/base properties of higher oxidation states than three are of very considerable interest in redox catalysts. When a catalyst is to be made in water a major problem arises from hydrolysis of its open coordination sites to give $M(OH)$ or MO . In divalent ion chemistry this is not a problem since the H_2O molecule or the OH^- ion are not firmly bound if at all at $pH = 7$. In trivalent ion chemistry the necessary binding of anionic protein side chains as ligands for complex stability pushes the hydrolysis constants of $M(III)H_2O$ quite low and thus hydrolytic reactions are often avoided, for example in haem Fe(III) complexes, although advantage may be taken of them in some Fe(III) and Mn(III) enzymes. Thus the vacant sites are usually occupied by water. In oxidation state $M(IV)$, and higher, the very small cations of the late first transition series are invariably heavily hydrolysed to MO , oxo-cations, and are of very high redox potential. The metals are not available for direct coordination to substrate in reactions but only for redox electron transfer reactions since O^{2-} is not a leaving group from say FeO and MnO . Higher oxidation state transition metal ion complexes of the second and third series i.e. MO complexes can act in the donation and acceptance of the oxo ligand since these metal ions are of higher coordination number and hydrolyse easily to $M(OH)$ complexes. The first and perhaps only available metal of this kind for biology is molybdenum. It is also a metal with a wide range of oxidation states. Notably in biology it acts in the transfer of O from sulphate, nitrate and carboxylate and in the handling of N_2 probably via MoN . The intermediates $-OH$, and $=NH$, $-NH_2$ are readily transferred.

This concludes the description of the acid/base properties of the metals. Before turning to redox properties we must remember that all the properties are tuned by the protein and assisted by further interactions of substrates with protein side-chains.

TABLE 2. σ -Acid-base binding reactions of metal ions in enzymes

	Ligand (Substrate)	Second Substrate
Zinc(II)	H_2O , OH^- , $EtOH$, HCO_3^-	peptides, nucleotides, NAD^+
Manganese(III)	OH^- ? rare	phosphate ester (acid)
	$O_2^{\cdot-}$	$O_2^{\cdot-}$
Iron(III)	OH^-	phosphate esters
	Phenolates	O_2
	$O_2^{\cdot-}$	$O_2^{\cdot-}$
(haem)	HO_2^-	H_2O_2 , e^-
	NO_2^- , SO_3^{2-}	e^-
Fe_4S_4	H^-	H^+
Copper(II)	Amines	O_2
	$S_2O_3^{2-}$	
Nickel(II)	Urea	H_2O
Molybdenum(IV)	NO_3^- , SO_4^{2-}	e^-

REDOX PROPERTIES OF METAL IONS

The redox properties of metal ions which we must keep in mind are the overall capacity for redox equivalents of a given centre and the redox potentials. In general single metal ion sites have the following redox capacity Mn(2), Fe(2), Mo(3), Cu(1). In clusters the redox capacities of the metals remain potentially the same but the tighter the metal/metal association the less available are the higher oxidation states. We turn to a description of redox potentials.

Just as the coordination partners of metal ions alter greatly acid/base properties so they adjust quite radically redox potentials. A general impression of the unavoidable effect of limitations of biological chelate chemistry is given in Fig. 6. Important points are that

(i) iron can have a redox capacity of one-electron in the range -500 to +450 mV, Fe(II)/Fe(III), in haem or simple protein complexes, or in a cluster could have a redox capacity of two electrons in this range. There is also the possibility of a further redox change in the range >+800 mV but this is for the Fe(III)/Fe(IV) and Fe(IV)/Fe(V) couples. These high potential couples increase the redox capacity of iron. (ii) Molybdenum gives a three electron capacity couple from Mo(III) to Mo(VI) each one electron step of which lies in the -300 mV range. (iii) Copper gives a one electron couple Cu(I)/Cu(II) in the +300 to +800 mV range and possibly a second couple Cu(II)/Cu(III) in the >800 mV range. (iv) Cobalt is restricted to very low potentials <-300 mV for both Co(II)/Co(III) and Co(I)/Co(II) couples while (v) manganese has a somewhat unknown range of potentials with Mn(II)/Mn(III) at about +500 mV and above Mn(III)/Mn(IV) at perhaps +400 mV. Figure 6 shows that Cu and Mn potentials match those of O₂ while those of Co and Mo match only H₂/N₂. Fe covers the whole range with one gap around +500 mV.

Distal groups of proteins

The redox properties of a metal-site like their acid properties are conditioned not just by the immediate coordination sphere but since enzymes have long-range structure distal groups from 5Å to even perhaps 20 to 30Å away can be important. It is the distal regions which generate the extreme specificity of enzymes. The metal ions have to be bound by certain co-ordination partners to gain certain regions of stability and selectivity but the protein sequence then decides which substrates can visit these sites. Evolution then refined the binding site of the substrate and the metal site by adjustment of the sequence of the distal regions of the protein so that the total catalyst was optimally "designed". Particularly important are the charged groups in the relatively close vicinity of the metal ion. It would appear that with one and the same coordination sphere the redox potential of a metal ion can be adjusted over a range of half a volt by its surrounds e.g. haem bis - imidazole complexes from -0.3 to +0.2 volts.

MECHANISMS OF REDOX REACTIONS

The following sections of this paper will direct attention to particular aspects of redox mechanisms in metalloproteins.

Electron transfer reactions

The electron occupies no space. The energy and activation energy for electron transfer is made low provided that (i) the two couples concerned in the electron transfer are of the same redox potential (ii) they are not too far apart in space <15Å (iii) the individual (metal) centres and their surrounding solvents (protein interiors) relax readily from one oxidation condition to the other. Elsewhere we have described how control by the protein of bond length, cytochrome c, and bond angles, plastocyanin, in the metal complexes (entatic strain) generates some of the required properties, (Ref.2), Fig. 7, and how others are created by suitable arrangements of structure and mobility of the protein in all regions running from the metal out to the surface of the protein. This has been shown by structural and spectroscopic, especially n.m.r. methods, in great detail for cytochrome c, (Ref.9). Control over the properties of other electron transfer proteins such as the iron-sulphur proteins undoubtedly rests in the way in which the protein manipulates the Fe/S bonds to the iron and again the whole protein sequence. The lesson from these electron-transfer proteins is clear. The metallo-proteins have more enhanced functional value than the sum of their two parts, a small (model) metal complex plus a protein. Thus model studies can only tell part of the story.

Before turning to more complicated reactions it is necessary to point to another feature of electron transfer in cytochrome-c (Ref.9). The change of redox state of the iron loosens the Fe-thioether (Methionine-80) bond and since this lies in the sequence region between the two freely mobile aromatic groups, Phe-82 and Tyr-74, this region adjusts on change of redox state and allows adjustment of adjacent residues from other parts of the sequence e.g. Ile-57. Now this part of the sequence carries several lysines which are essential for the binding of cytochrome-c to cytochrome oxidase. Thus this region can act as a signalling region informing the neighbour of cytochrome c, i.e. cytochrome oxidase, as to the oxidation state of cytochrome-c. It is frequently the case that proteins which belong to organised systems adjust their conformations during reaction cycles. This feature of biological catalysts allows control over catalysis. A commonly used example of such protein control is the action of allosteric effectors within tetrameric haemoglobin.

Biological electron transfer is frequently in a chain of hop-conductor centres. It is essential to space the electron transfer centres correctly, about 15Å apart. Another function which a protein forms is then the organisation of space so that electron flow is controlled in direction. In this sense the protein is functional in that it gives direction to the electron flow - otherwise it is merely a space-filler i.e. excluding water which prevents electron transfer over large distances. A further function of the protein is that it can

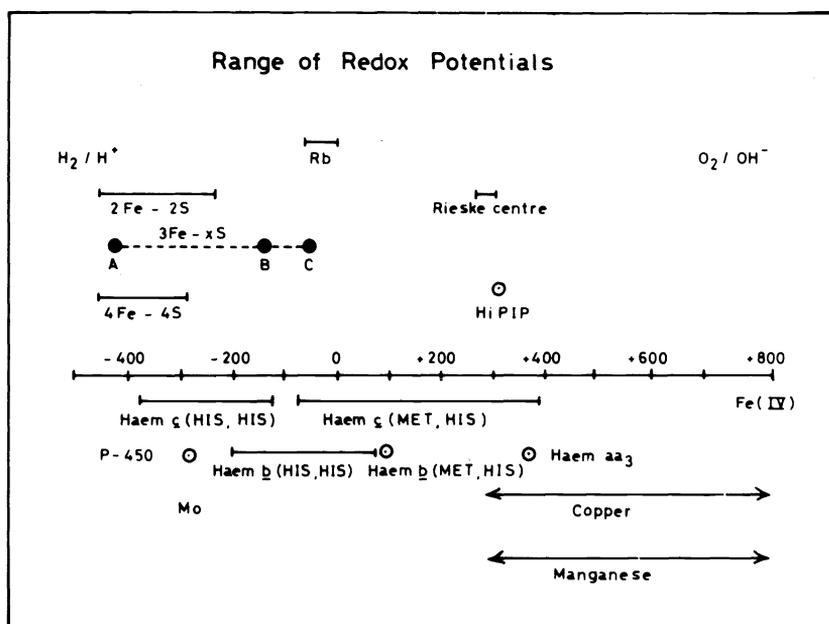

Fig. 6. The ranges of redox potentials of different biological metal ions in the range of H_2/H^+ to O_2/OH^- . Rb, rubredoxin; HiPIP, high potential iron protein.

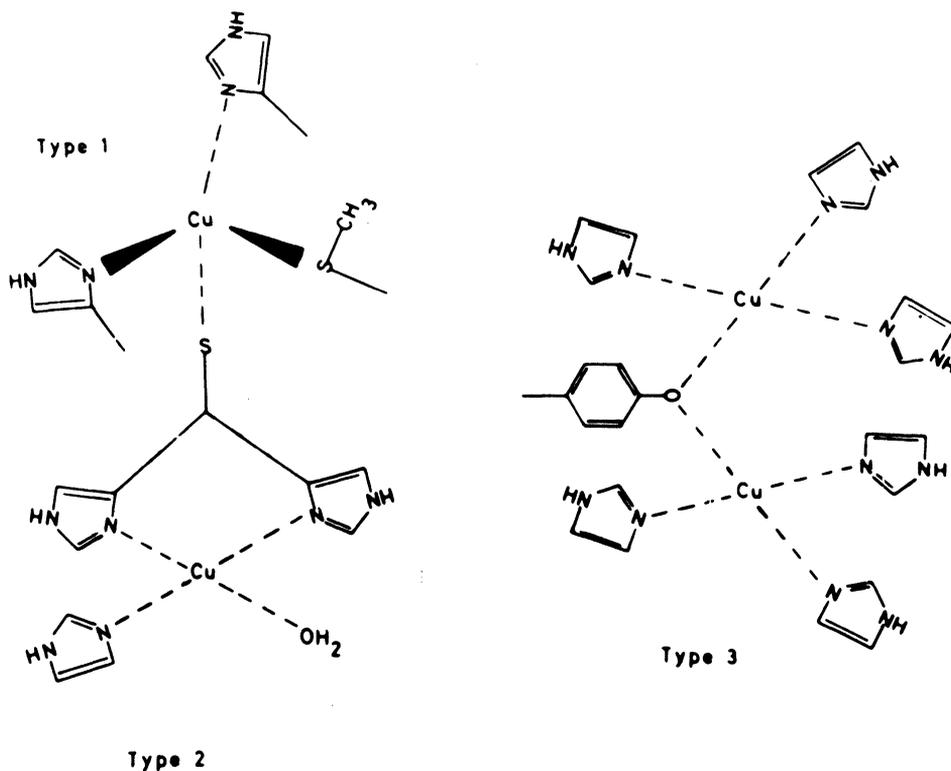

Fig. 7. The different types of copper centres in proteins (after Malmström). Type 1 is the electron transfer centre, Type 3 is the O_2 -carrier and with Type 2 becomes an O_2 -activator. The geometries are designed for optimal function. All the metals are in the middle of the protein, see Fig. 1(a).

bind protons (or other reagents) which then adjust either the redox potential or the spacing of electron carriers and so control electron flow rates.

Di-oxygen reactions (Ref. 4)

Our knowledge of di-oxygen chemistry in biology is sufficient to allow us to make some general summarizing statements.

(1) Binuclear Fe_2 , Cu_2 , FeCu , $\text{Mn}_2(?)$ centres do not activate O_2 and are not activated by O_2 so as to generate attack on organic molecules. Di-oxygen is clearly relatively kinetically inert in the species $\text{M.O}_2\text{M}$ as indeed it is in H_2O_2 . It follows that since M_2O appears as a 'stable' intermediate in the reduction of M_2O_2 to water, the oxygen atom is also not an aggressive species on this form. Thus O_2 is either bound reversibly or reduced in one electron steps by bi- or tri-nuclear metal centres without attack on organic matter.

(2) O_2 becomes increasingly aggressive when reduced in mononuclear complexes to $\text{M.O}_2^{\cdot-}$ and then MO . The degree of reduction before reaction depends upon the redox potential of the metal centre and sources of ancillary electrons. It is reasonably certain that $\text{M}^+\text{O}_2^{\cdot-}$ lies close in energy to M.O_2 . However $\text{M}^+\text{O}_2^{\cdot-}$ may be the ground state of M.O_2 . However $\text{M}^+\text{O}_2^{\cdot-}$ is not very aggressive and O_2 insertion using it as an intermediate requires rather a highly activated aromatic molecule (e.g. a phenol) as acceptor which must be bound adjacent to the M.O_2 reaction centre.

(3) Only Fe and Mn of the series of metals from Mn to Zn can give FeO or MnO readily, Fig. 6. FeO is a highly aggressive oxidant but it can only be made from O_2 , $\text{O}_2^{\cdot-}$ or H_2O_2 and Fe(II) or Fe(III) if the redox potential of the Fe(III)/Fe(IV) couple is brought down into the range of about +1.0 volt. The ligands which will do this can be recognised as they force the Fe(II)/Fe(III) couple below 0.0 volt. Iron enzymes and their redox potentials (Fe(II)/Fe(III)) in volts are as follows: haemoglobin (+0.2), myoglobin (+0.1), superoxide dismutase (+0.35) cytochrome oxidase (+0.35), none of which can easily generate FeO in mononuclear form; which are to be contrasted with peroxidase (-0.2), cytochrome P-450 (-0.3), catalase (-0.5) all of which give FeO . {When FeO is apparently formed in cytochrome oxidase or CuO is apparently formed in laccase it is really FeOCu or CuOCu which is present (i.e. MO stabilised in a bridge, see above). In a similar manner the high oxidation potentials seen for the couples Cu(I)/Cu(II) , +0.4, and Mn(II)/Mn(III) , +0.3, as in dismutases signify a coordination chemistry which prevents O_2 , $\text{O}_2^{\cdot-}$ and H_2O_2 from raising the mono-nuclear metals to the oxo-cations which are now too high in redox energy. In fact we do not know examples of mono-nuclear Mn or Cu going to the oxo-cations in reactions with oxygen in biology.

(4) Whether FeO_2 acts as an O_2 -insertion catalyst or, through FeO , as an O-atom insertion catalyst also depends on the connection which the Fe centre has to one electron reductants to give FeO . Even where FeO is reached the unit needs to be further activated by such ligands as thiolate if it is to attack very stable organic molecules, e.g. the attack on alkyl chains by cytochrome P-450.

(5) All M.O_2 complexes could act as one electron acceptors but then they might well release $\text{O}_2^{\cdot-}$ or H_2O_2 . MO_2 is rarely used in this way. $\text{Fe(H}_2\text{O}_2)$ or M_2O_2 as in peroxidases or laccases are chosen as one-electron oxidants since they do not release intermediate radicals.

The design of a haem or other metal centre in an enzyme for using dioxygen is then dependent upon

- (a) Control of spin-states for O_2 uptake and binding, as in haemoglobin.
- (b) Control of redox-states of the metal (by the whole protein).
- (c) Activation by a fifth ligand, e.g. RS^- as in P-450.
- (d) Creation of an adjacent site (O- or O_2 -insertion) or a remote site (one-electron reactions) for an organic substrate.
- (e) Supply of electrons from a secondary source.
 - (a) implies that the iron complex is on the high-spin/low-spin border and is, or readily becomes, open-sided. Haem generates this chemistry together with protein side-chains.
 - (b) implies that the fifth ligand, substitution in the porphyrin, manipulation of the second or third coordination sphere, or protein strain can be used to favour Fe(III) or Fe(II) or FeO .
 - (c) implies that there are kinetic barriers to FeO reactions.
 - (d) implies that the reaction which occurs depends on protein specificity not dependent on O_2 or Fe .
 - (e) provides a way to go to FeO_2 , to FeO and to Fe(II) without attack on a substrate.

Predictions are then possible in other series of iron proteins. The non-heme enzymes which activate O_2 will need to be of very low Fe(II)/Fe(III) potential if they are to activate OH insertion but not if they are to achieve O_2 -insertion. Moreover O_2 insertion does not require RS^- ligands while O-insertion into inert molecules probably does. We suspect that the non-haem iron centres for O_2 -insertion are like one or other of those seen in hemerythrin, Fig. 8, while those for O-insertion into hydrocarbons have one RS^- -ligand, more than one carboxylate, and an ancillary system for electron supply. The reason such proteins were supplanted by haem enzymes is that in the Fe(II) state they are not very stable.

(f) O_2 is not used as a simple one-electron oxidant with single metal centres. Rather H_2O_2 is so used or O_2 is used with binuclear centres.

This account reveals the many requirements for adjustment of the metal coordination sphere and its surrounds which are necessary if selectivity of a redox process is to be achieved. I stress that in my opinion it is essential that the use of the metal is defined very precisely and that this is done by the way the fold energies of the protein affect the structure and dynamics of the metal centre. Even when there are metal complexes with identical first coordination spheres the protein can alter grossly their functions as in myoglobin, peroxidases and tryptophan pyrrolase; all of which have an iron protoporphyrin linked to a protein through one histidine only.

While the function of metal centres in oxidases is decided by the protein biological systems face the further problem of putting these catalysts in those parts of space where they are stable, see later.

Low-redox potential reactions: H-transfer reactions

Hydrogen transfer reactions usually take place at low-redox potential in the range from -0.5 to +0.2 volts. Examples are H_2 (-0.45), pyruvate (-0.5), succinate (0.0), quinols (<+0.2). They always occur in cells and apart from their metabolic importance are central to energy capture. Many two electron (hydride) transfers are catalysed by NAD but there are several hydrogen atom reactions catalysed by either Co(III) and Fe_4S_4 centres. The curiosity of some of these reaction centres is that they are not used in oxidation/reduction but in rearrangement reactions which require radicals, Table 3. More conventional reactions are $H_2/2H^+$, ribose \rightarrow deoxyribose, and probably flavin and quinone redox changes. It would appear that part of the difficulty in understanding these reactions is that the metal is saturated and not open-sided both in the B_{12} coenzymes and in Fe_4S_4 . Now we know the way in which the metal is activated in the case of B_{12} coenzyme - the Co(III)- CH_2^- bond is broken to give the free radicals Co(II) and $\cdot CH_2^-$. $\cdot CH_2^-$ is the active species at the enzyme site. [In an alternative centre for a similar reaction, ribonucleotide reductase, a phenolate/ $Fe(III)_2O$ centre becomes by oxidation a phenol \cdot (tyrosine radical)]. Now it seems plausible that the bond breaking in the B_{12} coenzymes is due to strain in the coordination sphere. We can write the same strain for the iron reactions

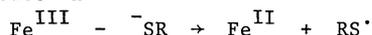

and use RS' as the catalyst for some reactions of H-transfer or rearrangement or the Fe^{II} as the centre for other reactions. RS' could become a swinging arm of Fe_4S_4 (compare the above CH_2^- , flavin, and coenzyme A) for the transfer of H' in the mitochondrial chain both at site I and at site (II), Rieske protein.

If this is the case then the pathway of hydrogen through membranes from redox site to redox site in order to store the energy of charge separation uses metal and non-metal centres. It is known that there are Fe_4S_4 centres at site I and site II of oxidative phosphorylation and site III contains a centre similar to that of plastocyanin. Plastocyanin reaction centre undergoes a conformational change of its ligands with pH. From Fig. 6 it will be seen that for low potential redox reactions a choice was possible between iron, molybdenum, and cobalt. Closer inspection shows that selective pressure has led to the handling of nitrogen (N_2 , NO_3^-) by molybdenum, hydrogen by iron (H_2), carbon by cobalt (CH_3^-) and oxygen by iron (H_2O_2 or O_2). Although no thorough explanation of this selection is yet possible we can see that it is connected with the following factors in addition to the redox potential of any one electron couple: (a) the total redox capacity (b) the range of redox potentials of the metal relative to those of the non-metal. Oxidation state diagrams for biological complexes show that the range is large for oxygen, iron and manganese, much smaller for carbon/oxygen compounds, nitrogen hydrides and molybdenum and cobalt. To these thermodynamic factors we must add the kinetic barriers inherent in the chemistry of the metals in different series of oxidation states - i.e. ability to expand the coordination sphere and the charges, spin-states and covalence of the metal centres. Comparing the handling of H_2 and O_2 by iron we note the differences of the sulphide and porphyrin ligands. Sulphide does not support high-oxidation state of low-spin chemistry, porphyrin does both - sulphide makes a very electron-rich centre which is necessary for H_2 chemistry while porphyrin has a stronger electron-acceptor role. We shall go a long way in the understanding of catalysis when we appreciate fully the selection of metals and ligands which has been made by biology ignoring at first the function of the protein in all its complexity.

The requirement for molybdenum

Apart from its association with N_2 -reduction where molybdenum can act uniquely as a store of three electrons at low potential, molybdenum is used by biology in a variety of two electron (atom) redox steps. $NO_3^- \rightarrow NO_2^-$, $SO_4^{2-} \rightarrow SO_3^{2-}$, $COOH \rightarrow CHO$. Why not use FeO or MnO? One answer probably lies in redox potentials. MoO in Mo(VI) goes to Mo(IV) at about -0.3 volts while the FeO(IV)/Fe(II) and MnO(IV)/Mn(II) couples have redox potentials at about +1.0 and >+0.5 volts respectively. The non-metal couples have the following potentials SO_3^-/SO_2^- (~ 0.0), NO_2^-/NO_3^- (+0.2), $-CHO/-COOH$ (~ 0.0). Molybdenum can act in two-electron O-transfer redox reactions quite outside the potentials where first-row transition metals act. This is due to the rapid changes of stability with oxidation state in the first series in contrast with the

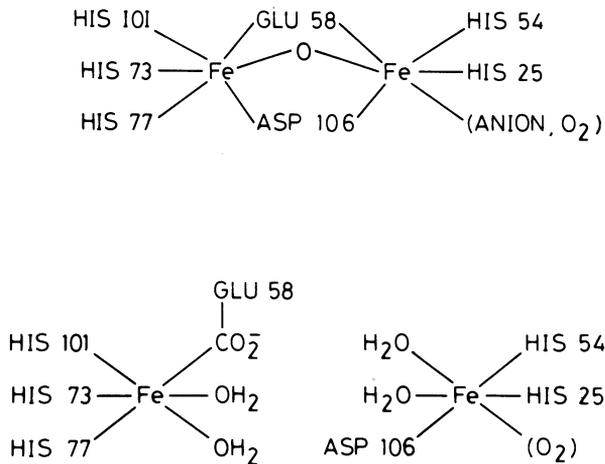

Fig. 8. The coordination of iron(III) in hemerythrin (top) and the proposed coordination of iron(II) in the same protein (bottom). The movement of the iron moves helices as in haemoglobin and makes the oxygen uptake cooperative. The metal ions are inside the protein, Fig. 1(a). Movement of helices by binding to the outside site Fig. 1(b) is seen in calcium-binding trigger proteins.

TABLE 3. Radicals in Metallo-Enzymes

<u>Metallo Enzyme</u>	<u>Radical Function</u>
B ₁₂ -catalysts (many) cobalt(II)	-CH ₂ [•] acts as rearrangement centre -CH ₂ [•] acts in ribose reduction
Ribonucleotide Reductase Iron(III)	Phenolate [•] acts in ribose reduction
Cytochrome-c Peroxidase Iron(IV)	Indole [•] acts in electron transfer
Peroxidase/Catalases Iron(IV)	Porphyrin [•] acts in electron transfer
Reaction Centres (Light) Magnesium(II)	Chlorin [•] acts in electron transfer Fe.Quinole [•] also acts in electron transfer

slower changes in the second series. The second advantage is mechanistic in that Mo-OH bonds are relatively readily made and broken. As stressed earlier MoO (and MoS) is a much weaker acid than many other MO complexes and picks up protons especially in oxidation states IV and V. Thus it can act in the transfer of OH or O. Again in high oxidation states molybdenum has a high coordination number, which allows bond breaking and making by S_N2 reaction (compare C with Si). It is my view that just as proteins have evolved to adjust stereochemistry around zinc to take full advantage of switches between four and five coordination so strain induced at molybdenum will be found to allow easy switch between five and six coordination. (This could well provide a further example of the entatic state).

The final advantage of molybdenum complex ion chemistry rests in the thermodynamic stability of its complexes. Molybdenum like copper and zinc gives very stable metallo-enzymes unlike Fe(II) and Mn(II). It is then of interest to compare the use of different oxidases as in Table 4, since only the very stable metallo enzymes can be employed outside cells.

The use of cobalt

The use of cobalt is confined almost exclusively to the reactions of vitamin B₁₂. The very fact that a special ligand has evolved in order to capture this rare element and to separate it from all other elements is an indication of its functional value. The ligand, corrin, is special in that (i) it forces the chemistry of cobalt to be low-spin chemistry; (ii) it provides such a strong field that the redox potentials of Co(I)/Co(II) and Co(II)/Co(III) are close to those of H₂/H⁺, i.e. the Co(III) form is stable in all mildly oxidising conditions, which allows transport of the metal in oxidising media outside cells in a very stable form. (iii) It is roughly planar generating a very strong field in the plane and making the fifth and sixth coordination positions reactive.

Now the availability of low-spin Co(II) generates a very special d -electron configuration, the d^7 with one orbital, d_{z^2} , very exposed and holding one electron. This orbital is a very fast but weak radical scavenger and together with the redox poise of the complex it permits the reaction

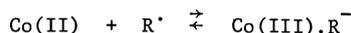

to be reversible. The reaction in the reverse direction generates a radical, R[·], which becomes the source of catalysis of radical rearrangements and ribose reduction in B₁₂-enzymes. (A somewhat similar radical is found in another form of ribose reductase - an iron enzyme with a tyrosine radical). Coenzyme B₁₂ is then the major source of radical carbon reactive sites for reactions which are best performed using carbon radical intermediates. The actual reactions which use the radical path are something of a surprise, especially the rearrangements, but there is a general parallel with the use of tributyl tin radicals generated from Bu₃SnH as developed by Barton and his coworkers for synthetic purposes. In other words coenzyme B₁₂ is not just a Grignard reagent. However the use of cobalt(I)/cobalt(III) reactions, Grignard chemistry, may not have been excluded and it may be that in methyl-transfer the d^8 state, which is a very powerful nucleophile, is used. (Low-spin d^8 chemistry may also occur in the Ni(II) tetrapyrrole catalysts which have now been found in certain bacteria). We note overall that it is the symbiosis of cobalt chemistry (including its uptake and transport), of corrin ring synthesis, and of the production of special proteins which help to labilise the Co-carbon bond which has produced a very special catalytic (radical) centre. Of course all the radical reactions are in a special protein substrate cage by means of which the reactions are made selective. There is a parallel with the oxygen-insertion reactions of P-450 where the mechanism of reaction uses low-spin iron d^4 and d^5 and where the radical is in the π -system but also in the z -direction for the transfer of OH[·] to the substrate radical R[·], see above. Only iron and cobalt can generate these special intermediates used so idiosyncratically in biology.

COMPARTMENTS AND CATALYSTS

Against this background we can enquire why biological systems found it to be necessary to use not just one metal, iron, but five Fe, Cu, Mn, Co and Mo in handling of dioxygen and hydrogen and the subsequent transfer of oxygen and hydrogen atoms amongst substrates. We shall describe iron reactions only somewhat further as they are sufficiently mentioned above and in many publications. Cobalt is rarely used except in vitamin B₁₂. We turn to Cu, Mo and Mn. It appears that two factors have dominated the way in which these metal ions are used (1) the redox potential ranges possible for their different redox couples as described above and (2) the intrinsic stability of their complex ions in different parts of space. Copper and molybdenum can be readily employed in any region of an organism but iron and manganese cannot, (Ref.10), since the first two metal form very stable complex ions in all oxidation states while iron and manganese do not. Examples will now be given.

TABLE 4. The compartments of some metal/proteins

Activity	Co-factor	Site
Amine-Oxidases	Flavin	Mitochondria
	Copper	Extracellular
Aldehyde Oxidase (Xanthine)	Mo	Extracellular
Superoxide Dismutases	Mn, Fe	Mitochondria
		Prokaryote Cytoplasm
Oxygen Carriers	Cu	Eukaryote Cytoplasm
	Fe (Haem)	Usually Intracellular
	Cu	Extracellular

Redox proteins in compartments

A very interesting case of compartmental segregation of redox enzymes is the separation of the manganese superoxide dismutase (Mn SOD) in mitochondria, and iron superoxide dismutase in prokaryotic cells from the copper enzyme (Cu SOD) of the cytoplasm of higher cells. Primitive cells with no internal membranes have either Mn SOD or Fe SOD. It would therefore appear that the search for a superoxide dismutase has produced three alternative possibilities. Closer inspection suggests that this may not be the case and that the copper enzyme has arisen as a response to the development of cellular compartments. Ions were then selectively pumped, Fig. 9. Of the redox metal ions only copper forms metallo-enzymes of sufficient stability against dissociation to be used outside cells and to a lesser degree in the cytoplasm of eukaryotic cells. Examples are haemocyanin and oxidases.

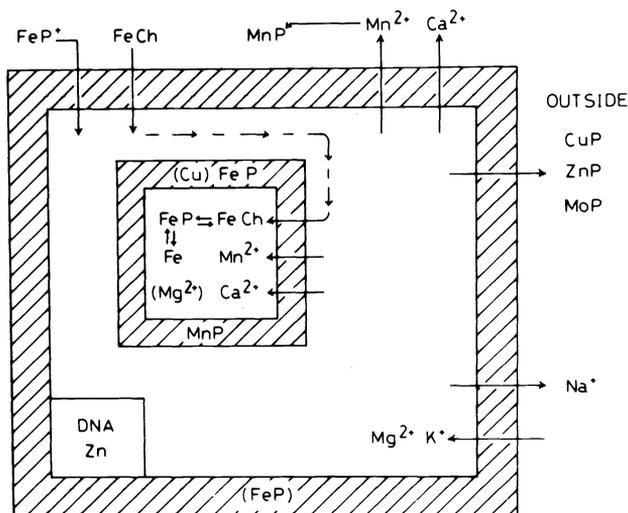

Fig. 9. An illustrative diagram showing how metal ions are placed in biological compartments either by pumping of ions, e.g. Na^+ , K^+ , Mg^{2+} , Ca^{2+} or Mn^{2+} , or of metal complexes e.g. Fe^{3+}Ch , where Ch is a chelating ligand, or even by the pumping and binding of proteins especially those which contain haem, Zn^{2+} , Cu^{2+} , Fe^{3+} , corrin and molybdenum.

SUMMARY

This lecture has shown how metal ions can be selectively partitioned directly through energised gradients or by chemical binding to proteins followed by transport. The refinement of geometry at the site of binding has heightened the catalysis potential (entatic state). However catalysis demands motion not only of the entering substrate and leaving product but also of the catalytic groups and the substrate through intermediates. Some of the protein rearrangements are relatively small as in carbonic anhydrase, Fig. 3, but they can be large

as in phosphate transfer, Fig. 5. In redox reactions the important motions are small for electron transfer catalysis but are much bigger for atom-transfer i.e. H- or O-transfer Fig. 10. Vitamin B₁₂ reactions provide an example of H-transfer reactions while the P-450 protein, or any other hydroxylase, gives an example of O-transfer. Both require protein

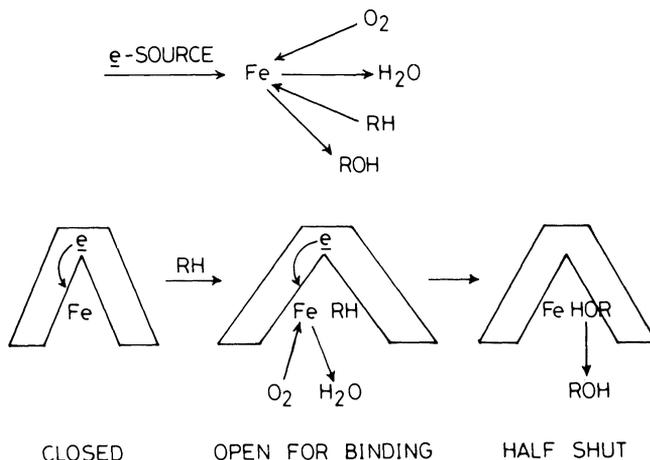

Fig. 10. The nature of the catalytic steps in hydroxylation. The enzyme has the metal (Fe) in a closed environment which opens on reduction to Fe(II) to allow binding of substrate (RH). Oxygen binds next but is immediately split to water and FeO(IV) which causes the enzyme to half shut pushing the FeO against the RH. There follows a migration of H to give FeOH and a return migration of OH to give ROH. The product ROH leaves giving the closed enzyme. Note how the hinge reactions required parallel the phosphate transfer of Fig. 5 but start from the open step of the cycle. The oxygen reactions like the ATP-reactions need a required-order mechanism in order to prevent extraneous reactions.

movements on the same scale as ATP-phosphorylation reaction since both reactions demand protected environments. Appreciation of catalysis therefore needs an understanding of energy states and their mobility within structure. A common feature of many enzymes would seem to be local movement of segments through hinge bonding. In the case of haem-proteins it is the underpart of the haem which is made to be mobile, Fig. 10, as is observed in haemoglobins and cytochrome c to a smaller degree.

REFERENCES

1. R.J.P. Williams, *Proc. Royal Soc. (London)* B294, 57-74 (1981).
2. B.L. Vallee and R.J.P. Williams, *Proc. Natl. Acad. Sci. (U.S.A.)*, 59, 498-502 (1968).
3. R.J.P. Williams, *FEBS Letters* (1982) in press.
4. Oxygen and Life, *Second BOC Priestley Conference* (1980) Royal Soc. Chem. (London) Special Pub. No. 39, London.
5. I. Bertini, C. Luchinat and A. Scozzafava, *Structure and Bonding* 48, 45-92 (1982).
6. A.E. Dennand and R.J.P. Williams, *J. Chem. Soc. (London)* 612-618 (1966A).
7. C.S.G. Phillips and R.J.P. Williams, *Inorganic Chemistry* Vols. I and II, Oxford University Press, Oxford, England (1966).
8. F.A. Cotton and G. Wilkinson, *Advanced Inorganic Chemistry*, Interscience, New York (1975).
9. G.R. Moore and R.J.P. Williams, *Europ. J. Biochem.* 103, 503-550 (1980).
10. R.J.P. Williams in *The Biology and Chemistry of Active Oxygen* (eds. J.V. Bannister and W.H. Bannister) Elsevier, New York (1982).