

# RECENT DEVELOPMENTS IN THE FIELD OF ION SELECTIVE ELECTRODES

W. SIMON, E. PRETSCH, D. AMMANN, W. E. MORF, M. GÜGGI,  
R. BISSIG and M. KESSLER\*

*Laboratorium für Organische Chemie, Eidgenössische Technische  
Hochschule, Zürich, Switzerland and Max-Planck-Institut für  
Systemphysiologie, Dortmund, GFR*

## ABSTRACT

On the basis of model calculations, a series of electrically neutral lipophilic molecules was designed and synthesized. These carrier ligands may be tailored to ion selectivities suitable for practical application as components in liquid-membrane electrodes selective for  $\text{Ca}^{2+}$ ,  $\text{Ba}^{2+}$ ,  $\text{Li}^+$  and  $\text{Na}^+$  respectively. Some of the selectivities observed are far superior to systems known to date. By incorporating these ligands in PVC membranes, lifetimes of more than one year may be obtained. Through a special treatment with lipophilic anions (e.g. tetraphenylborate), silver surfaces may be coated with thin layers of ligand-impregnated PVC to obtain metal contacted membrane electrodes of high e.m.f. stability. They are perfectly suited for use as components in flow-through and in miniaturized electrode systems.

---

The recent efforts in the field of ion selective electrodes were concentrated on the fundamental understanding of the membrane processes involved<sup>1-7</sup>, the development of newer applications of available electrode systems<sup>3, 5-8</sup> as well as the design of new ion sensors<sup>3, 5-7</sup>.

The different types of ion selective membrane electrodes known so far may be classified as follows (see, however, ref. 6):

(a) *Solid membranes* (fixed ion exchange sites)

Homogeneous: Glass membrane

Crystal membrane

Heterogeneous: Crystalline substance in inert matrix

(b) *Liquid membranes* (mobile ion exchange sites)

Charged ligand

Neutral ligand

(c) *Special electrodes*

Gas sensing electrodes

Enzyme substrate electrodes

---

\* Max-Planck-Institut.

In the last few years, the development of new ion selective electrodes was mainly directed towards special electrodes (gas sensing electrodes<sup>9,10</sup>, enzyme substrate electrodes<sup>11-13</sup>) as well as liquid membrane electrodes<sup>14-21</sup>. Liquid membrane sensors offer a wide range of accessible ion selectivities. In these electrodes, mobile ion selective sites (e.g. an ion selective ligand dissolved in an appropriate solvent) are interposed between the sample solution and a reference system as shown schematically in *Figure 1* for a microelectrode<sup>22</sup> and a more conventional ion electrode. By incorporating the mobile sites into solvent impregnated PVC, systems of high electromotive and mechanical stability with electrode lifetimes of more than one year may be obtained<sup>21</sup> (*Figure 1*). Since a miniaturization of liquid membrane electrodes is easily realized and since such tools are attractive for biomedical applications<sup>23</sup>, efforts in our laboratory were directed towards the design of ion selective ligands for alkali and alkaline earth metal cations.

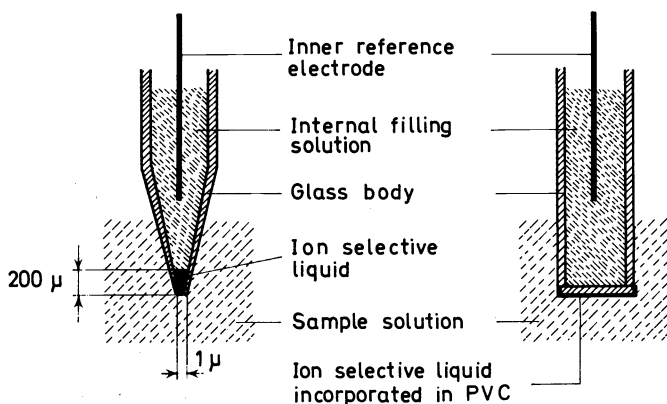

*Figure 1.* Schematic representation of liquid-membrane micro-<sup>22</sup> and PVC-electrodes<sup>21</sup>.

In a first approximation, the e.m.f. of an electrochemical cell containing a membrane electrode can be described by an extended Nicolsky equation

$$E = E_0 + (RT/z_i F) \ln [a_i + \sum_{j \neq i} K_{ij}^{\text{Pot}} (a_j)^{z_i/z_j}] \quad (1)$$

where  $E$  denotes the cell potential (e.m.f.),  $E_0$  is a constant reference potential,  $a_i$  is the activity of a primary ion  $I^{z_i}$  in the sample solution,  $a_j$  is the activity of an interfering ion  $J^{z_j}$  in the sample solution,  $K_{ij}^{\text{Pot}}$  is the selectivity factor, characteristic of a given membrane, and  $RT/F$  is the Nernst factor.

If the liquid membrane does not contain a complexing agent for the monovalent cations  $I^+$  and  $J^+$  the selectivity factor measuring the preference of  $J^+$  relative to  $I^+$  by the sensor may be approximated by the ratio of the partition coefficients  $k_j$  and  $k_i$  of the respective cations between the sample solution and the membrane<sup>14,24,25</sup>

$$K_{ij}^{\text{Pot}} = k_j/k_i \quad (2)$$

Outstanding selectivities between cations may be obtained if a selective complexing agent for the ion to be measured is incorporated into the membrane phase. For electrically neutral ligands S the selectivity between cations of the same charge becomes<sup>14, 24, 25</sup>

$$K_{ij}^{\text{Pot}} = (k_j/k_i) (K_{js}/K_{is}) \quad (3)$$

where  $K_{js}$ ,  $K_{is}$  are the complex formation constants between the ligand S and the cations within the membrane. The selectivity factor  $K_{ij}^{\text{Pot}}$  given in equation (3) corresponds to the equilibrium constant for the exchange reaction ( $z = 1$ ):

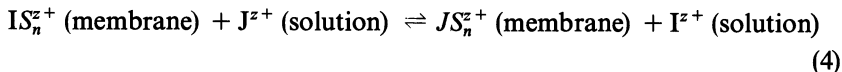

For electrically charged ligands  $S^-$  selectivity factors are observed that lie somewhere between the limiting values given by equations (2) and (3)<sup>14</sup>; thus, the potential for selective behaviour as suggested by the quotient  $K_{js}/K_{is}$  of the complex formation by  $S^-$  often cannot be fully exploited for controlling the selectivity of the corresponding sensors. Equation (3), however, suggests that extremely high selectivities can be achieved by using neutral ion-specific ligands (ion carriers, ionophores) as membrane components. This is the reason why the design and synthesis of ligands was initiated in this direction.

In order for such ligands to behave as carriers for metal cations in a lipophilic membrane, the most important requirements are the following:

(1) *Lipophilicity*: The ligand and the complex have to be sufficiently soluble in the membrane phase.

(2) *Mobility*: An adequate mobility of both ligand and complex are guaranteed only as long as the overall dimensions of the carrier remain within limits, but are still compatible with high lipid solubility.

(3) *Complex formation constant  $K_{is}$* : The electrode response becomes especially selective for the ion I if  $K_{ij}^{\text{Pot}}$  is small [equation (1)]. This is true for  $K_{is} k_i \gg K_{js} k_j$ . Furthermore, it can be shown theoretically and experimentally<sup>26</sup> that a cation response is obtained only if an excess of uncomplexed ligand is present within the membrane, e.g.  $K_{is}$  has an acceptable upper limit. The limiting value for  $K_{is} k_i$  is of the order of unity if a cationic response up to 1 M sample solutions is demanded.

(4) *Kinetics*: The ion exchange kinetics [equation (4)] have to be compatible with the demanded response time of the membrane electrode.

High-selectivity complexing agents for hard cations are multidentate ligands which lock the cation in question into a rather rigid arrangement of coordinating sites<sup>25, 27</sup>. The most important molecular parameters for such a complexing agent that fulfils the requirements mentioned above are:

(a) *Coordination number, cavity*: A carrier molecule should be a multidentate ligand which is able to assume a stable conformation that provides a cavity; the cavity formed by a given number of polar coordinating groups, is suited for the uptake of a cation, while the non-polar groups form a lipophilic shell around the coordination sphere. A cavity that snugly fits the cation in question is desirable<sup>25</sup>.

(b) *Ligand atoms*: For A-cations, the polar coordinating groups preferably contain oxygen as ligand atoms. Principally, amine-nitrogens conform to the specifications given<sup>28</sup> but were avoided here, however, in order to eliminate interference by protonation reactions.

(c) *Arrangement of the coordinating centres*: These centres should preferably be arranged so as to form five-membered chelate rings with the non-solvated cation I<sup>29</sup>.

(d) *Size of the ligand*: A small thickness of the ligand layer around the central atom leads to a preference of divalent relative to monovalent cations of the same size; this is of special importance when using polar membrane solvents<sup>30</sup>.

(e) *Dipole moment of the coordinating sites*: Increasing dipole moments increase the stability of the complex and increase the preference of divalent relative to monovalent cations of the same size, other parameters (e.g. orientation of dipole) remaining constant<sup>25</sup>.

The antibiotics valinomycin and the macrotetrolides<sup>25</sup> ideally meet the requirements mentioned above and are used in a variety of commercially available electrodes for the measurement of K<sup>+</sup> (valinomycin) and NH<sub>4</sub><sup>+</sup> (nonactin, monactin)<sup>31</sup>. Unfortunately, other highly selective natural products similarly predestined as components for ion selective electrodes have not yet been found. Certain representatives of the synthetic crown compounds<sup>32</sup> show selectivities of K<sup>+</sup> over Na<sup>+</sup> and can be used as components in liquid-membrane electrodes<sup>33</sup>. The highest selectivities of K<sup>+</sup> over Na<sup>+</sup> found<sup>19,20</sup> are still an order of magnitude lower than those obtained when using valinomycin<sup>31,34</sup>, however. Due to low lipophilicity [see (1)] and especially so to slow exchange kinetics [see (4)], the synthetic macroheterobicyclic ligands<sup>28</sup>, which show very high selectivities for A-cations, are unfortunately unsuitable as components for liquid membrane electrodes. In perfect agreement with requirements (b), (c) and (d) a number of polyethyleneglycols show selectivities for divalent relative to monovalent cations; they have been used as components in sensors for Ba<sup>2+</sup><sup>35</sup>.

## NEW ION SELECTIVE ELECTRODES BASED ON NEUTRAL LIGANDS

According to requirements (a) to (e) inclusive, above, a series of carrier molecules suitable for liquid membrane electrodes responsive to alkali and alkaline earth metal cations have been synthesized. Out of 154 molecules prepared the four shown in *Figure 2* are, so far, the most attractive ones.

The selectivity of such ligands can be drastically influenced by the choice of the membrane solvent. An increase in the dielectric constant of a typical membrane solvent (water-immiscible liquid of low vapour-pressure, compatible with PVC, no functional groups which can undergo protonation reactions) increases the selectivity of divalent over monovalent cations of the same size and vice versa<sup>25</sup>. The power residing within this parameter is illustrated in *Figure 3*. To determine the selectivity factors presented in *Figure 4* membrane solvents have been chosen correspondingly.

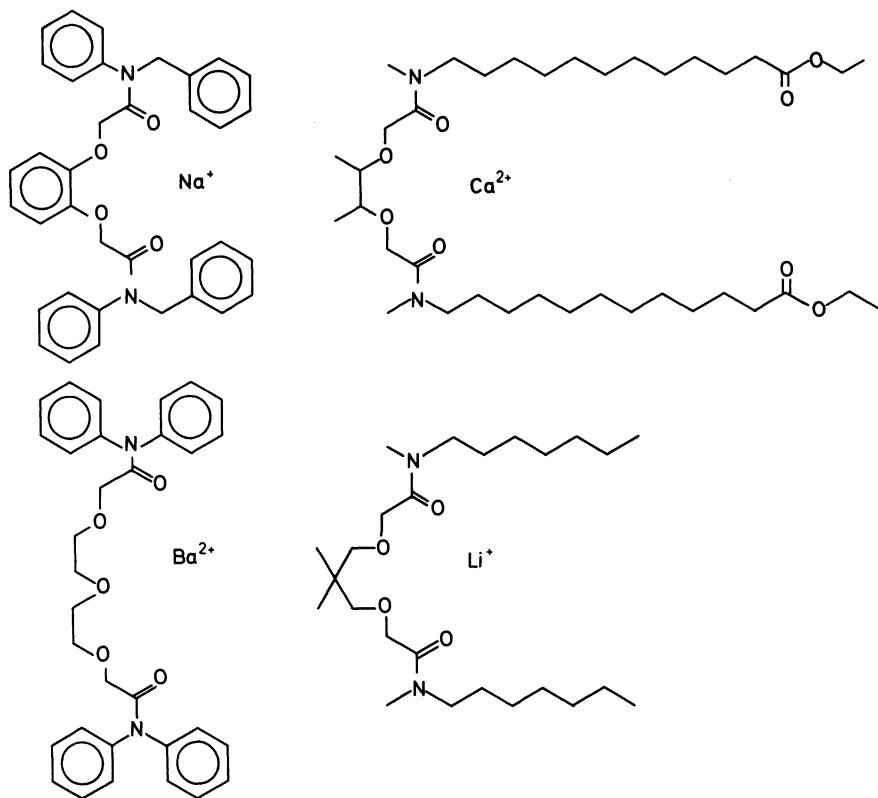

Figure 2. Structure of synthetic ion-selective ligands showing selectivities for Ca<sup>2+</sup>, Ba<sup>2+</sup>, Na<sup>+</sup> and Li<sup>+</sup> respectively.

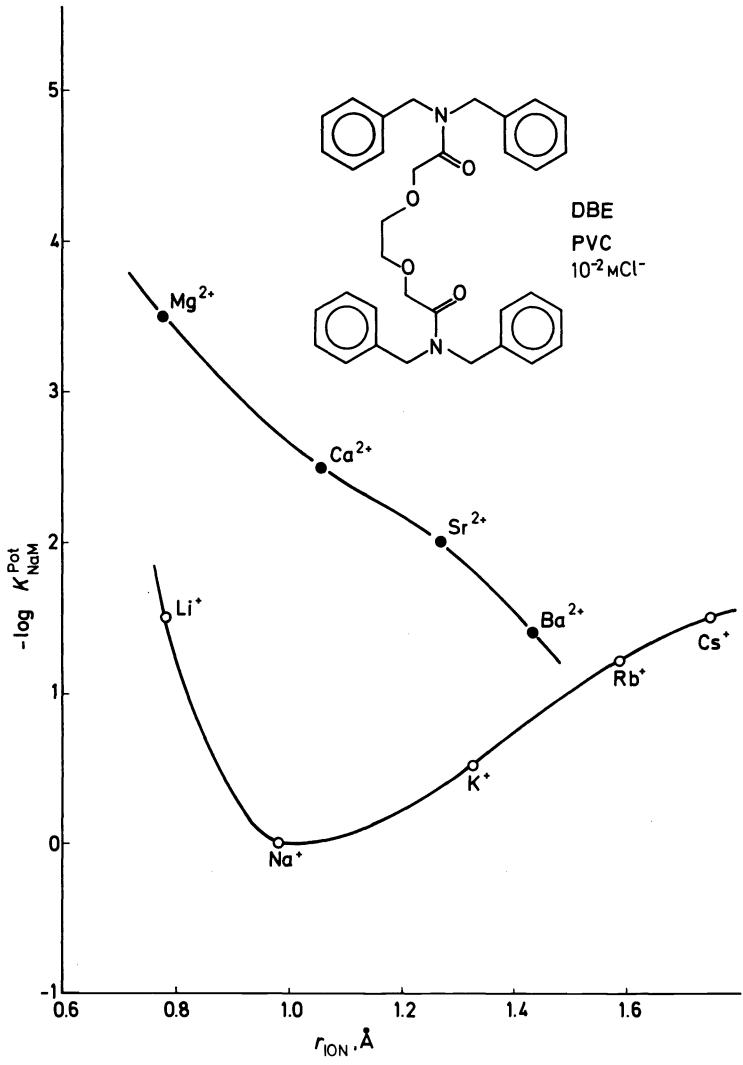

Figure 3(a)

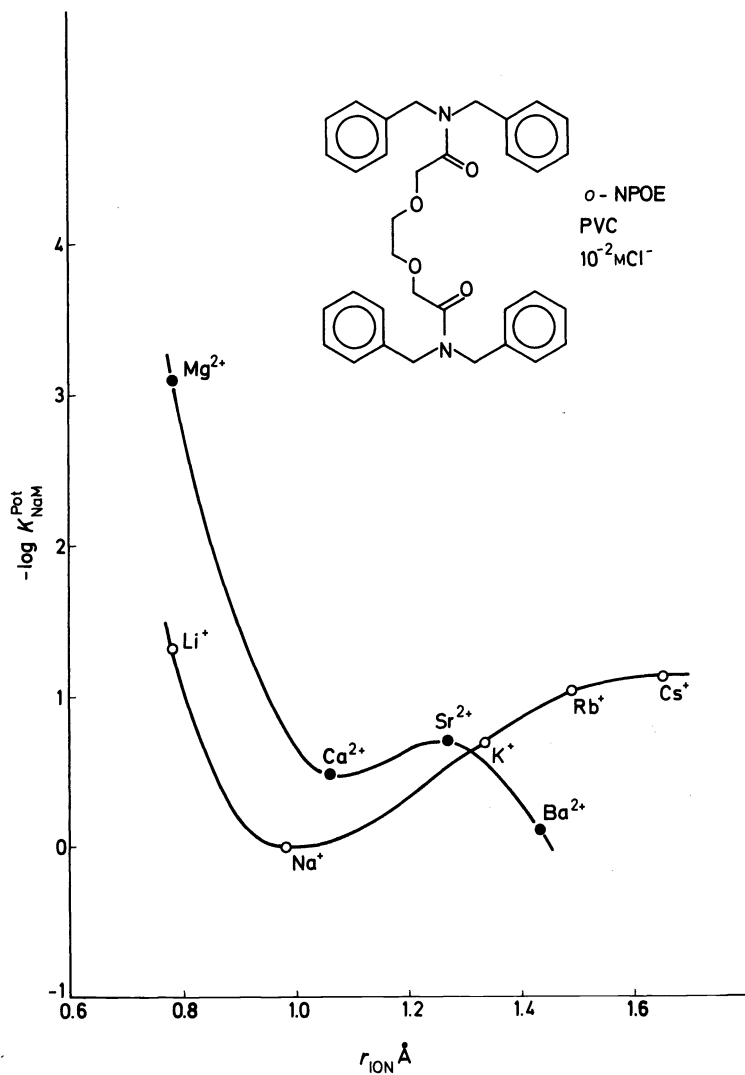

Figure 3(b)

Figure 3. Influence of the membrane solvent on the selectivity of the corresponding neutral carrier liquid membrane electrodes<sup>36</sup> (a) DBE; (b)  $\sigma$ -NPOE.  $\sigma$ -NPOE is  $\sigma$ -nitro-phenyl-n-octyl-ether (dielectric constant  $\approx 24$ ); DBE is dibenzylether (dielectric constant  $\approx 4$ ).

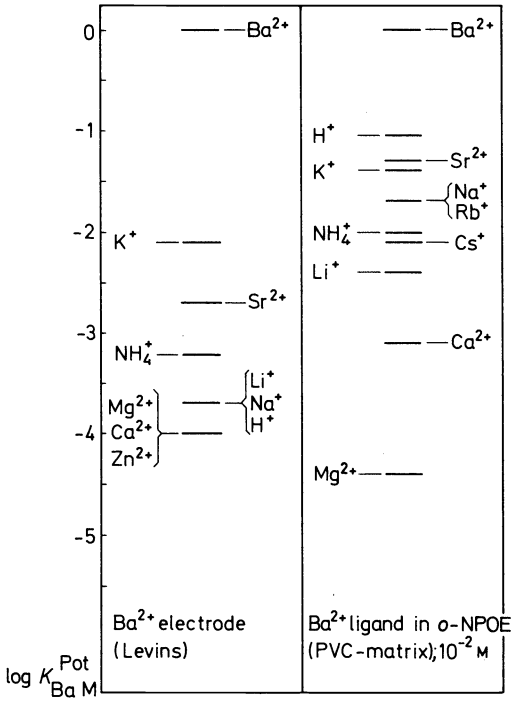
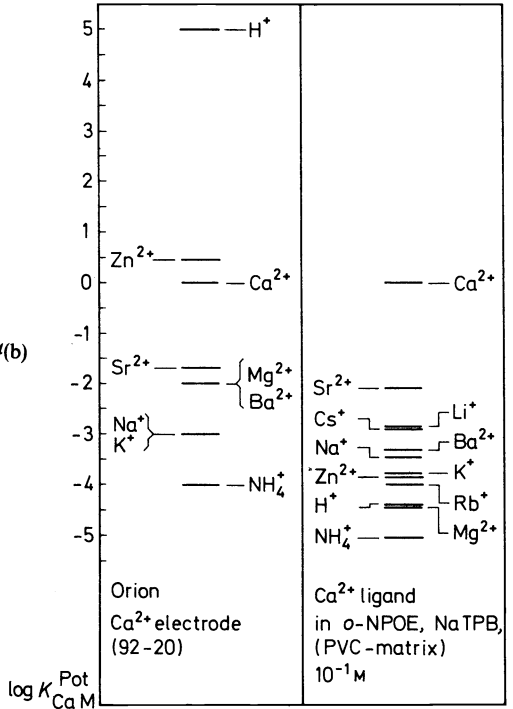

Figure 4(a)

Figure 4(b)





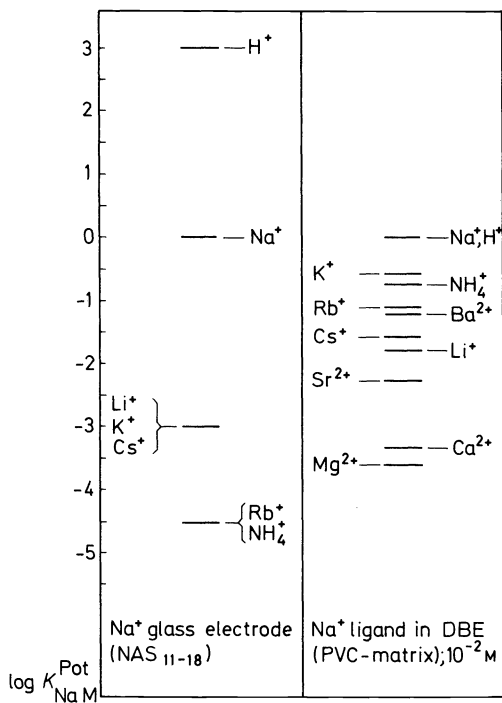

Figure 4(c)

Figure 4(d)

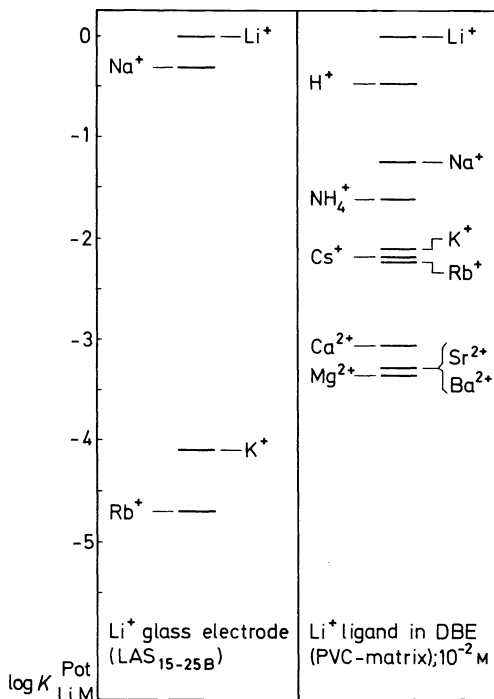

Figure 4. Comparison of the selectivity factors obtained for the neutral carrier membrane electrodes by the separate solution technique with values for (b) the Orion 92-20 Ca<sup>2+</sup> electrode<sup>21, 31</sup>, (c) Na<sup>+</sup> - <sup>31</sup>, (d) Li<sup>+</sup> - <sup>39</sup> glass electrodes as well as (a) a neutral carrier Ba<sup>2+</sup> membrane electrode<sup>35</sup>

Figure 4 clearly demonstrates that the selectivity of the  $\text{Ca}^{2+}$  sensor based on the neutral carrier shown in Figure 2 is especially in respect to  $\text{Mg}^{2+}$ ,  $\text{H}^+$  and  $\text{Zn}^{2+}$  far superior to the values for the Orion liquid-ion-exchange electrode<sup>21, 31, 37</sup>. Although much higher selectivities in respect to  $\text{Na}^+$  have been claimed for a PVC electrode with modified ion-selective component<sup>16</sup> the neutral carrier electrode shows far superior performance (see Figure 5).

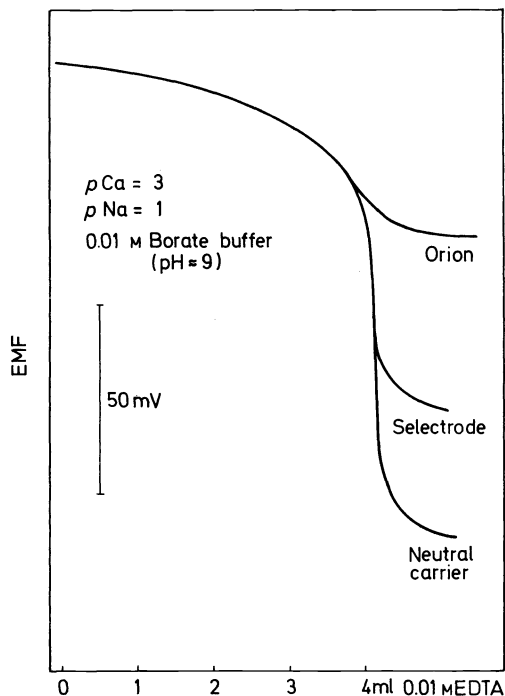

Figure 5. Titrations of  $1.0 \times 10^{-3} \text{ M CaCl}_2$  with EDTA at pH 9 using a neutral carrier electrode<sup>40</sup> (see Figures 2 and 4), an Orion 92-20 electrode (see Figure 6 in ref. 16) as well as a Selectrode (see Figure 6 in ref. 16).

Since the discrimination of  $\text{Na}^+$  and  $\text{K}^+$  is adequate for blood serum studies and the discrimination of protons,  $\text{Zn}^{2+}$  and  $\text{Mg}^{2+}$  is exceptionally high, it appears that the electrode described here is unsurpassed as far as measurements in blood serum are concerned. In measurements of total calcium activities in blood serum, protein bounded  $\text{Ca}^{2+}$  can be replaced by  $\text{Zn}^{2+}$  ions and therefore high selectivities relative to  $\text{Zn}^{2+}$  are of interest<sup>38</sup>.

The  $\text{Ba}^{2+}$  selective liquid membrane electrode<sup>40</sup> displays, except for magnesium, worse selectivities than the  $\text{Ba}^{2+}$  sensor described by Levins throughout<sup>35</sup>. Because our electrodes show a much higher e.m.f. stability with lifetimes of longer than 11 months, however, and the design of ligands selective for  $\text{Ba}^{2+}$  ions still being in progress, further improvement of this electrode is probable.



*Figure 6. Scanning electron microscope view of multichannel microelectrode tips (see also ref. 45). (Courtesy of Mr. D. Schäfer and Mr. K. Zierold).*

A  $\text{Na}^+$  selective electrode based on a neutral carrier has been described recently<sup>36</sup> (see *Figure 3*). The ligand presented in *Figure 2* shows somewhat higher selectivities, increased solubility in the membrane phase and may be used for electrodes of considerably increased lifetime<sup>41</sup>. Although the selectivities of sodium-responsive glass electrodes are usually superior<sup>1, 31</sup>, except in respect to protons, this and further improved sodium liquid membrane electrodes will bring advantages, especially in blood serum measurements and in the preparation of microelectrodes (see below).

The first  $\text{Li}^+$  selective electrode based on a neutral carrier is presented here<sup>40, 42</sup>. Although its selectivity relative to  $\text{Na}^+$  is not yet adequate for a direct monitoring of  $\text{Li}^+$  in blood serum, e.g. in the therapy of maniacal depressive psychosis<sup>43</sup>, it might be attractive as a reference electrode. In such applications a constant activity of  $\text{Li}^+$  in the sample solution has to be generated.

### ELECTRODE DESIGN

The measurement of intracellular activities of ions is a difficult technical problem. Liquid membrane microelectrodes (see *Figure 1*) have been used for this purpose<sup>22</sup>. The neutral ligands described here are ideally suited for

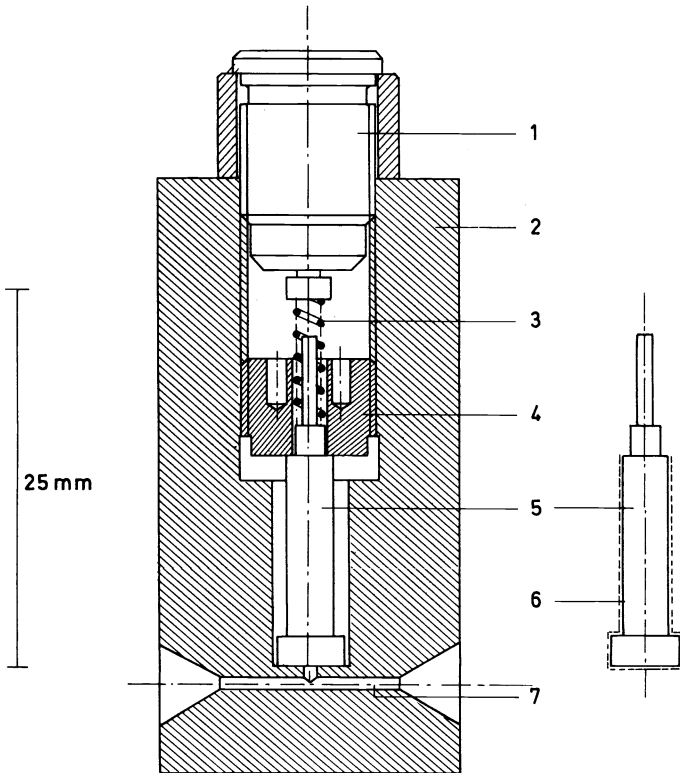

*Figure 7.* Flow-through membrane electrode: 1—plug, 2—plastic electrode body, 3—metal spring, 4—plastic screw to fix membrane carrier, 5—membrane carrier (silver), 6—PVC membrane, 7—sample channel.

such an application. Multi-channel microelectrodes with tip diameters of about 1  $\mu\text{m}$  and up to four channels have been prepared (see *Figure 6*). They are potentially useful for the measurement of activity ratios of different ions in extremely small sample volumes<sup>44</sup>.

It has been pointed out repeatedly<sup>46-48</sup> that the interference in the cation response by lipid-soluble sample anions is still a severe limitation of neutral carrier liquid membrane electrodes. A theoretical treatment<sup>49,50</sup> shows, however, that there are means to eliminate or at least reduce such an anion interference by the permanent incorporation of lipophilic anions, e.g. tetraphenylborate, into the membrane phase. This tetraphenylborate may simultaneously be used to produce a thermodynamically reversible couple with silver, by covering silver with silver-tetraphenylborate. These surfaces may be coated with thin layers of ligand-impregnated PVC to obtain metal contacted membrane electrodes<sup>51,52</sup> of high e.m.f. stability. They are suited for use as components in flow-through (see *Figure 7*) and miniaturized electrode systems. For multi-ion monitoring several of the units shown in *Figure 7* (approximately 10  $\mu\text{l}$  dead volume per unit) may be stacked together.

### FUTURE PROSPECTS

There is no doubt that a more detailed study of the selectivity/structure relationship<sup>25</sup> will help in designing molecules with ion selectivities far superior to those obtained so far. In view of the analytical use of enzyme reactions<sup>11-13</sup>, the measurement of  $\text{NH}_4^+$  is of special interest and therefore the design of such electrodes is actively pursued. Since chiral ion selective ligands can be prepared<sup>53</sup>, we hope to be able to obtain enantiomer-selective liquid membrane electrodes in due time.

### ACKNOWLEDGEMENT

This work was partly supported by the Schweizerischer Nationalfonds zur Förderung der wissenschaftlichen Forschung.

### REFERENCES

- <sup>1</sup> G. Eisenman in *International Symposium on Modern Technology in Physiological Sciences*, p 245. J. F. Gross, R. Kaufmann, E. Wetterer, Eds. Academic Press: New York (1973).
- <sup>2</sup> G. A. Rechnitz, *Pure Appl. Chem.* **36**, 457 (1973).
- <sup>3</sup> J. Koryta, *Anal. Chim. Acta*, **61**, 329 (1972).
- <sup>4</sup> H.-R. Wuhrmann, W. E. Morf and W. Simon, *Helv. Chim. Acta*, **56**, 1011 (1973).
- <sup>5</sup> R. P. Buck, *Anal. Chem.* **46**, 28R (1974); **44**, 270R (1972).
- <sup>6</sup> A. K. Covington, *CRC Critical Reviews in Analytical Chemistry*, **3**, 355 (1974).
- <sup>7</sup> E. Pungor and K. Tóth, *Pure Appl. Chem.* **36**, 441 (1973).
- <sup>8</sup> E. Pungor and K. Tóth, *Vom Wasser*, Vol. 42, p 43. Verlag Chemie: Weinheim (1974).
- <sup>9</sup> J. W. Ross, J. H. Riseman and J. A. Krueger, *Pure Appl. Chem.* **36**, 473 (1973).
- <sup>10</sup> J. Ruzicka and E. H. Hansen, *Anal. Chim. Acta*, **69**, 129 (1974).
- <sup>11</sup> G. G. Guilbault in *Enzyme Engineering*, p 361. L. B. Wingard Jr, Ed. Wiley: New York (1972).
- <sup>12</sup> H. H. Weetall, *Anal. Chem.* **46**, 603A (1974).
- <sup>13</sup> G. G. Guilbault, R. K. Smith and J. G. Montalvo Jr, *Anal. Chem.* **41**, 600 (1969).
- <sup>14</sup> W. E. Morf, D. Ammann, E. Pretsch and W. Simon, *Pure Appl. Chem.* **36**, 421 (1973).
- <sup>15</sup> E. Pretsch, D. Ammann and W. Simon, *Research/Development*, **25** (3), 20 (1974).

- 16 J. Ruzicka, E. H. Hansen and J. Chr. Tjell, *Anal. Chim. Acta*, **67**, 155 (1973).
- 17 M. Sharp, *Diss. University Umea*, Umea (1973).
- 18 H. B. Hermann and G. A. Rechnitz, *Science*, **184**, 1074 (1974).
- 19 J. Petránek and O. Ryba, *Abstracts of IUPAC Meeting, Cardiff*, April 1973, Paper 13.
- 20 O. Ryba, E. Knižáková and J. Petránek, *Coll. Czech. Chem. Commun.* **38**, 497 (1973); O. Ryba and J. Petránek, *J. Electroanal. Chem.* **44**, 425 (1973).
- 21 G. J. Moody and J. D. R. Thomas, *Selective Ion-Sensitive Electrodes*, Merrow: Watford, Herts., UK (1971).
- 22 J. L. Walker Jr, *Anal. Chem.* **43**, 89A (1971).
- 23 G. A. Rechnitz, *Research/Development*, **24** (8), 18 (1973).
- 24 G. Eisenman, in R. A. Durst (Ed.), *Ion-Selective Electrodes*, National Bureau of Standards, *Spec. Publ. No. 314*: Washington (1969).
- 25 W. Simon, W. E. Morf and P. Ch. Meier, *Structure and Bonding*, **16**, 113 (1973).
- 26 W. E. Morf and W. Simon, in *Ion-selective Electrodes*, M. S. Frant and J. W. Ross, Eds., in press.
- 27 H. Diebler, M. Eigen, G. Ilgenfritz, G. Maass, R. Winkler, II ICCG, Haifa, 1968; *Pure Appl. Chem.* **20**, 93 (1969).
- 28 B. Dietrich, J. M. Lehn, J. P. Sauvage, *Tetrahedron Letters*, **34**, 2885, 2889 (1969).
- 29 G. Schwarzenbach, *Helv. Chim. Acta*, **35**, 2344 (1952).
- 30 W. E. Morf and W. Simon, *Helv. Chim. Acta*, **54**, 2683 (1971).
- 31 K. Cammann, *Das Arbeiten mit ionenselektiven Elektroden*, Springer-Verlag: Berlin (1973).
- 32 C. J. Pedersen, *J. Amer. Chem. Soc.* **89**, 2495, 7017 (1967); **92**, 386, 391 (1970).
- 33 G. A. Rechnitz and Ehud Eyal, *Anal. Chem.* **44**, 370 (1972).
- 34 L. A. R. Pioda, V. Stankova and W. Simon, *Anal. Letters*, **2**, 665 (1969).
- 35 R. J. Levins, *Anal. Chem.* **43**, 1045 (1971); **44**, 1544 (1972).
- 36 D. Ammann, E. Pretsch and W. Simon, *Anal. Letters*, **7**, 23 (1974).
- 37 Orion, *Electrode Specification* (1972).
- 38 T. F. Christiansen, private communication.
- 39 G. Eisenman in *Advances in Analytical Chemistry and Instrumentation*, Vol. 4, p 213. Wiley-Interscience: New York (1965).
- 40 M. Güggi, U. Fiedler, E. Pretsch and W. Simon, in preparation.
- 41 D. Ammann, R. Bissig, M. Güggi, E. Bretsch, W. Simon, I. J. Borowitz and L. Weiss, *Helv. Chim. Acta*, **58**, 1535 (1975).
- 42 P. M. Boron-Rettore, *Diplomarbeit ETH, Zürich* (1974).
- 43 G. Ceriotti in *Clinical Biochemistry*, p 1566. H. Ch. Curtius and M. Roth, Eds. Walter de Gruyter: Berlin, New York (1974).
- 44 W. Simon, E. Pretsch, W. E. Morf, M. Güggi, G. Kahr and M. Kessler, *The Society of Analytical Chemistry, Centenary Celebrations, Paper C 55*, London, July 1974.
- 45 E. Neher and H. D. Lux, *Pflügers Arch. Suppl.* **332**, R 88 (1972).
- 46 S. Lal and G. D. Christian, *Anal. Letters*, **3**, 11 (1970).
- 47 R. Scholer, *Diss. ETHZ Nr. 4940*, Zürich (1972).
- 48 J. H. Boles and R. P. Buck, *Anal. Chem.* **45**, 2057 (1973).
- 49 W. E. Morf, G. Kahr and W. Simon, *Anal. Letters*, **7**, 9 (1974).
- 50 W. E. Morf, D. Ammann and W. Simon, *Chimia*, **28**, 65 (1974).
- 51 R. W. Cattral and H. Freiser, *Anal. Chem.* **43**, 1905 (1971).
- 52 M. D. Smith, M. A. Genshaw and J. Greyson, *Anal. Chem.* **45**, 1782 (1973).
- 53 R. C. Helgeson, J. M. Timko and D. J. Cram, *J. Amer. Chem. Soc.* **95**, 3023 (1973).